

ENERPAC hydraulic cylinders are available in hundreds of different configurations. Whatever the industrial application... lifting, pushing, pulling, bending, holding... whatever the force capacity, stroke length, or size restrictions... single- or double-acting, solid or hollow plunger, you can be sure that Enerpac has the cylinder to suit your high force application. Enerpac jacking cylinders fully comply to ASME B30.1 (except RD-Series).



GR2 Bearing Technology

The exclusive GR2 is a unique bearing design on RC-Series DUO cylinders which absorbs eccentric load stresses to protect your cylinder against abrasion, over-extending or plunger blow-outs and jamming or top-end mushrooming. As a result, RC-Series DUO cylinders provide long, trouble-free operation.

Easy assembly and disassembly using only standard shop tools.

Heavy-duty, pre-tensioned spring improves retraction rate for enhanced productivity.

Unique GR2 Bearing System surrounds the seal of longer stroke models resulting in improved side-load resistance and extended operating life.

























Additional shape and texture to the **cylinder thread protector** and pliable plug-in/pop-off coupler cap for easy operation with gloved and oily hands.



Note: The cut-away drawing is representative of typical cylinder construction and may not represent all cylinders in this section.



Cylinder & Lifting Products Section Overview

* Capacity (tons)	Stroke Range (in)	Cylinder Type and Functions	Series		Page
5-100	.63-14.25	General Purpose Cylinders, Single-acting Cylinder Accessories 	RC-DUO		6 ▶ 10 ▶
20-150	1.97-9.84	Aluminum Cylinders Single-Acting, Solid Plunger, Lock Nut, Hollow Plunger 	RAC RACL RACH		12 ▶ 14 ▶ 16 ▶
20-150	1.97-9.84	Aluminum Cylinders Double-Acting Solid Plunger 	RAR		18 ▶
5-500	.25-2.44	Pancake and Low Height Cylinders, Single-Acting 	CLP RSM RCS		20 ▶ 22 ▶ 23 ▶
2.5-60	5.00-6.00	Pull Cylinders, Single-Acting 	BRC BRP		24 ▶
12-150	.31-10.13	Hollow Plunger Cylinders Single- and Double-Acting 	RCH RRH		26 ▶ 28 ▶
4-25	1.13-10.25	Precision Production Cylinders, Double-Acting 	RD		30 ▶
10-500	2.25-48.00	Long Stroke Cylinders, Double-Acting 	RR		32 ▶
50-1000	1.97-11.81	High Tonnage Cylinders Single-Acting (S/A), S/A with Mechanical Locknut, Double-Acting 	CLSG CLRG CLL		36 ▶ 40 ▶ 44 ▶
7-150 2-100	3.00-6.13 3.94-18.11	Aluminum and Steel Jacks Industrial Bottle Jack 	JHA/JH GBJ		48 ▶ 49 ▶
60-200	14.0-27.0	POW'R-RISER® Lifting Jack	PR		50 ▶
5-25	2.0-6.0	Extreme Environment Products (Valves, cylinders, hand pumps) 	RC P V		52 ▶
5-100	1.50-14.25	Cylinder - Pump Sets (Single-Acting) 	SC		54 ▶

* All cylinder capacities are nominal values, unless otherwise stated. [Maximum] capacities are theoretical and may vary, depending on cylinder condition and application.

▼ Shown from left to right: RC-506, RC-50, RC-2510, RC-154, RC-10010, RC-55, RC-1010



- Unique GR2 Bearing Design, reduces wear, extending life
- Collar threads, plunger threads and base mounting holes enable easy fixturing (on most models)
- Designed for use in all positions
- High strength alloy steel for durability
- Redesigned cylinder thread protector for ease of use
- Heavy-duty, pretensioned spring improves retraction speed
- Baked enamel finish for increased corrosion resistance
- CR-400 coupler and dust cap included on all models
- Plunger wiper reduces contamination, extending cylinder life

▼ Stage lifting set up in Greece, where assembled pipes, 82 feet in length, were stage lifted with six RC-2514 cylinders.



The Industry Standard General Purpose Cylinder



Saddles

All RC cylinders are equipped with hardened removable grooved saddles. For tilt and flat saddles, see the RC-Series accessory page.

Page: 10



Base Plates

To ensure the stability of cylinders for lifting applications, base plates are available for 10, 25 and 50 ton RC cylinders.

Page: 10



Specialty Attachments

For solving all kinds of application problems, specialty attachments are available for 5, 10 and 25 ton RC cylinders.

Page: 162

▼ RC cylinder mounting attachments greatly extend the application possibilities (available for 5, 10, 15 and 25 ton cylinders).



Single-Acting, General Purpose Cylinders



GR2 Bearing Technology

The exclusive GR2 is a unique bearing design on RC-Series DUO cylinders which absorbs eccentric load stresses to protect your cylinder against abrasion, over-extending or plunger blow-outs and jamming or top-end mushrooming. As a result, RC-Series DUO cylinders provide long, trouble-free operation.

▼ QUICK SELECTION CHART

For complete technical information see next page.

Cylinder Capacity	Stroke	Model Number	Cylinder Effective Area	Oil Capacity	Collapsed Height	Weight
tons (maximum)	(in)		(in ²)	(in ³)	(in)	(lbs)
5 (4.9)	.63	RC-50**	.99	.62	1.63	2.2
	1.00	RC-51	.99	.99	4.34	2.3
	3.00	RC-53	.99	2.98	6.50	3.3
	5.00	RC-55*	.99	4.97	8.50	4.1
	7.00	RC-57	.99	6.96	10.75	5.3
	9.13	RC-59	.99	9.07	12.75	6.1
10 (11.2)	1.00	RC-101	2.24	2.24	3.53	4.0
	2.13	RC-102*	2.24	4.75	4.78	5.1
	4.13	RC-104	2.24	9.23	6.75	7.2
	6.13	RC-106*	2.24	13.70	9.75	9.8
	8.00	RC-108	2.24	17.89	11.75	12.0
	10.13	RC-1010*	2.24	22.65	13.75	14.0
	12.00	RC-1012	2.24	26.84	15.75	15.0
	14.00	RC-1014	2.24	31.31	17.75	18.0
15 (15.7)	1.00	RC-151	3.14	3.14	4.88	7.2
	2.00	RC-152	3.14	6.28	5.88	9.0
	4.00	RC-154*	3.14	12.57	7.88	11.0
	6.00	RC-156*	3.14	18.85	10.69	15.0
	8.00	RC-158	3.14	25.13	12.69	18.0
	10.00	RC-1510	3.14	31.42	14.69	21.0
	12.00	RC-1512	3.14	37.70	16.69	24.0
	14.00	RC-1514	3.14	43.98	18.69	26.0
25 (25.8)	1.00	RC-251	5.16	5.16	5.50	13.0
	2.00	RC-252*	5.16	10.31	6.50	14.0
	4.00	RC-254*	5.16	20.63	8.50	18.0
	6.25	RC-256*	5.16	32.23	10.75	22.0
	8.25	RC-258	5.16	42.55	12.75	27.0
	10.25	RC-2510	5.16	52.86	14.75	31.0
	12.25	RC-2512	5.16	63.18	16.75	36.0
	14.25	RC-2514*	5.16	73.49	18.75	39.0
30 (32.4)	8.25	RC-308	6.49	53.56	15.25	40.0
50 (55.2)	2.00	RC-502	11.04	22.09	6.94	33.0
	4.00	RC-504	11.04	44.18	8.94	42.0
	6.25	RC-506*	11.04	69.03	11.13	51.0
	13.25	RC-5013	11.04	146.34	18.13	83.0
75 (79.5)	6.13	RC-756	15.90	97.41	11.25	65.0
	13.13	RC-7513	15.90	208.74	19.38	130.0
100 (103.1)	6.63	RC-1006	20.63	136.67	14.06	130.0
	10.25	RC-10010	20.63	211.45	17.69	160.0

* Available as a set. See note on this page.

** RC-50 cylinder has non-removable grooved saddle and no collar thread.

RC Series



Capacity:

5-100 tons

Stroke:

.63-14.25 inches

Maximum Operating Pressure:

10,000 psi



Think Safety
Manufacturer's rating of load and stroke are maximum safe limits.

Good practice encourages using only 80% of these ratings!

Page: 242



RAC-Series, Single-Acting Cylinders

The lightweight general purpose spring return aluminum cylinders.

Page: 12



RC-Series DUO Cylinders

maintain external dimensions for use with existing fixtures.



Gauges

Minimize the risk of overloading and ensure long, dependable service from your equipment. Refer to

the System Components section for a full range of gauges.

Page: 113

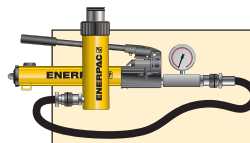

Pump and Cylinder Sets

All cylinders marked with an * are available as sets (cylinder, gauge, couplers, hose and pump) for your ordering convenience.

Page: 54

RC-Series DUO Cylinders, Single-Acting



Speed Chart

See the Enerpac Cylinder Speed Chart in our "Yellow Pages" to determine your approximate cylinder speed.

Page: 251

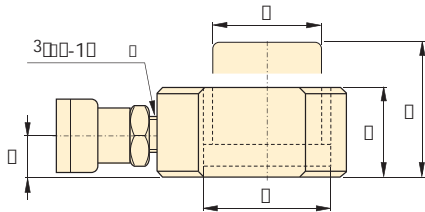
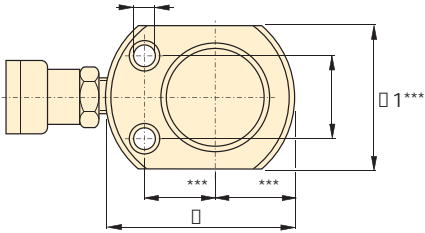

RC-50

RC-101 only
(U1 = .75 inch)

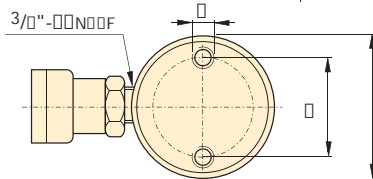
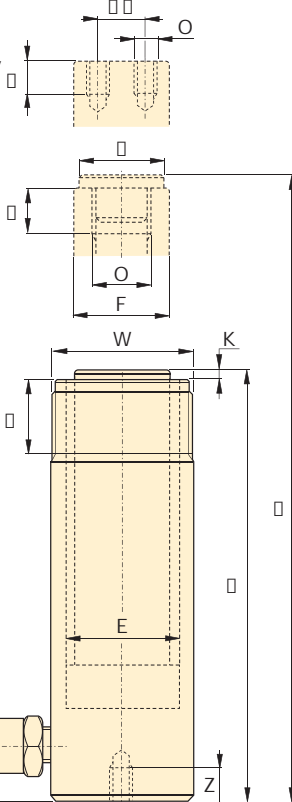

RC-51 to RC-5013 models

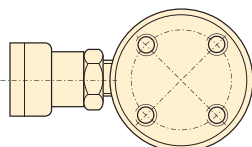

RC-1006 and RC-10010 models

◀ For full features see page 6.

Cylinder Capacity	Stroke	Model Number	Cylinder Effective Area	Oil Capacity	Collapsed Height	Extended Height	Outside Diameter
tons (maximum)	(in)		(in ²)	(in ³)	A (in)	B (in)	D (in)
5 (4.9)	.63	RC-50**	.99	.62	1.63	2.25	2.31
	1.00	RC-51	.99	.99	4.34	5.34	1.50
	3.00	RC-53	.99	2.98	6.50	9.50	1.50
	5.00	RC-55*	.99	4.97	8.50	13.50	1.50
	7.00	RC-57	.99	6.96	10.75	17.75	1.50
	9.13	RC-59	.99	9.07	12.75	21.88	1.50
10 (11.2)	1.00	RC-101	2.24	2.24	3.53	4.53	2.25
	2.13	RC-102*	2.24	4.75	4.78	6.91	2.25
	4.13	RC-104	2.24	9.23	6.75	10.88	2.25
	6.13	RC-106*	2.24	13.70	9.75	15.88	2.25
	8.00	RC-108	2.24	17.89	11.75	19.75	2.25
	10.13	RC-1010*	2.24	22.65	13.75	23.88	2.25
	12.00	RC-1012	2.24	26.84	15.75	27.75	2.25
	14.00	RC-1014	2.24	31.31	17.75	31.75	2.25
15 (15.7)	1.00	RC-151	3.14	3.14	4.88	5.88	2.75
	2.00	RC-152	3.14	6.28	5.88	7.88	2.75
	4.00	RC-154*	3.14	12.57	7.88	11.88	2.75
	6.00	RC-156*	3.14	18.85	10.69	16.69	2.75
	8.00	RC-158	3.14	25.13	12.69	20.69	2.75
	10.00	RC-1510	3.14	31.42	14.69	24.69	2.75
	12.00	RC-1512	3.14	37.70	16.69	28.69	2.75
	14.00	RC-1514	3.14	43.98	18.69	32.69	2.75
25 (25.8)	1.00	RC-251	5.16	5.16	5.50	6.50	3.38
	2.00	RC-252*	5.16	10.31	6.50	8.50	3.38
	4.00	RC-254*	5.16	20.63	8.50	12.50	3.38
	6.25	RC-256*	5.16	32.23	10.75	17.00	3.38
	8.25	RC-258	5.16	42.55	12.75	21.00	3.38
	10.25	RC-2510	5.16	52.86	14.75	25.00	3.38
	12.25	RC-2512	5.16	63.18	16.75	29.00	3.38
	14.25	RC-2514*	5.16	73.49	18.75	33.00	3.38
30 (32.4)	8.25	RC-308	6.51	53.56	15.25	23.50	4.00
50 (55.2)	2.00	RC-502	11.04	22.09	6.94	8.94	5.00
	4.00	RC-504	11.04	44.18	8.94	12.94	5.00
	6.25	RC-506*	11.04	69.03	11.13	17.38	5.00
	13.25	RC-5013	11.04	146.34	18.13	31.38	5.00
75 (79.5)	6.13	RC-756	15.90	97.41	11.25	17.38	5.75
	13.13	RC-7513	15.90	208.74	19.38	32.50	5.75
100 (103.1)	6.63	RC-1006	20.63	136.67	14.06	20.69	7.00
	10.25	RC-10010	20.63	211.45	17.69	27.94	7.00

* Available as a set. See page 54.

** RC-50 cylinder has non-removable grooved saddle and no collar thread.

*** D1 = 1.63 inch, L = .81 inch, M = 1.00 inch.

Single-Acting, General Purpose Cylinders

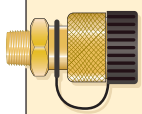

Couplers Included!
CR-400 couplers included on all models. Fits all HC-Series hoses.

Capacity:
5-100 tons

Stroke:
.63-14.25 inches





Maximum Operating Pressure:
10,000 psi

RC Series



Cylinder Bore Diam.	Plunger Diam.	Base to Adv. Port	Saddle Diam.	Saddle Protrusion from Plngr.	Plunger Internal Thread	Plunger Thread Length	Base Mounting Holes			Collar Thread	Collar Thread Length	Weight (lbs)	Model Number
							Bolt Circle U (in)	Thread V (in)	Thrd. Depth Z (in)				
E (in)	F (in)	H (in)	J (in)	K (in)	O (in)	P (in)	U (in)	V (in)	Z (in)	W (in)	X (in)		
1.13	1.00	.75	**	**	**	**	1.13	.22	—	—	—	2.2	RC-50**
1.13	1.00	.75	1.00	.25	3/4"-16	.56	1.00	1/4"-20UN	.56	1 1/2"-16	1.13	2.3	RC-51
1.13	1.00	.75	1.00	.25	3/4"-16	.56	1.00	1/4"-20UN	.56	1 1/2"-16	1.13	3.3	RC-53
1.13	1.00	.75	1.00	.25	3/4"-16	.56	1.00	1/4"-20UN	.56	1 1/2"-16	1.13	4.1	RC-55*
1.13	1.00	.75	1.00	.25	3/4"-16	.63	1.00	1/4"-20UN	.56	1 1/2"-16	1.13	5.3	RC-57
1.13	1.00	.75	1.00	.25	3/4"-16	.63	1.00	1/4"-20UN	.56	1 1/2"-16	1.13	6.1	RC-59
1.69	1.50	.75	—	—	#10-24UN	.25	1.56	5/16"-18UN	.50	2 1/4"-14	1.06	4.0	RC-101
1.69	1.50	.75	1.38	.25	1"-8	.75	1.56	5/16"-18UN	.50	2 1/4"-14	1.13	5.1	RC-102*
1.69	1.50	.75	1.38	.25	1"-8	.75	1.56	5/16"-18UN	.50	2 1/4"-14	1.06	7.2	RC-104
1.69	1.50	.75	1.38	.25	1"-8	.75	1.56	5/16"-18UN	.50	2 1/4"-14	1.13	9.8	RC-106*
1.69	1.50	.75	1.38	.25	1"-8	.75	1.56	5/16"-18UN	.50	2 1/4"-14	1.06	12	RC-108
1.69	1.50	.75	1.38	.25	1"-8	.75	1.56	5/16"-18UN	.50	2 1/4"-14	1.13	14	RC-1010*
1.69	1.50	.75	1.38	.25	1"-8	.75	1.56	5/16"-18UN	.50	2 1/4"-14	1.06	15	RC-1012
1.69	1.50	.75	1.38	.25	1"-8	.75	1.56	5/16"-18UN	.50	2 1/4"-14	1.06	18	RC-1014
2.00	1.63	.75	1.50	.38	1"-8	1.00	1.88	3/8"-16UN	.50	2 3/4"-16	1.19	7.2	RC-151
2.00	1.63	.75	1.50	.38	1"-8	1.00	1.88	3/8"-16UN	.50	2 3/4"-16	1.19	9	RC-152
2.00	1.63	.75	1.50	.38	1"-8	1.00	1.88	3/8"-16UN	.50	2 3/4"-16	1.19	11	RC-154*
2.00	1.63	1.00	1.50	.38	1"-8	1.00	1.88	3/8"-16UN	.50	2 3/4"-16	1.19	15	RC-156*
2.00	1.63	1.00	1.50	.38	1"-8	1.00	1.88	3/8"-16UN	.50	2 3/4"-16	1.19	18	RC-158
2.00	1.63	1.00	1.50	.38	1"-8	1.00	1.88	3/8"-16UN	.50	2 3/4"-16	1.19	21	RC-1510
2.00	1.63	1.00	1.50	.38	1"-8	1.00	1.88	3/8"-16UN	.50	2 3/4"-16	1.19	24	RC-1512
2.00	1.63	1.00	1.50	.38	1"-8	1.00	1.88	3/8"-16UN	.50	2 3/4"-16	1.19	26	RC-1514
2.56	2.25	1.00	2.00	.41	1 1/2"-16	1.00	2.31	1/2"-13UN	.75	3-12	1.94	13	RC-251
2.56	2.25	1.00	2.00	.41	1 1/2"-16	1.00	2.31	1/2"-13UN	.75	3 5/16"-12	1.94	14	RC-252*
2.56	2.25	1.00	2.00	.41	1 1/2"-16	1.00	2.31	1/2"-13UN	.75	3 5/16"-12	1.94	18	RC-254*
2.56	2.25	1.00	2.00	.41	1 1/2"-16	1.00	2.31	1/2"-13UN	.75	3 5/16"-12	1.94	22	RC-256*
2.56	2.25	1.00	2.00	.41	1 1/2"-16	1.00	2.31	1/2"-13UN	.75	3 5/16"-12	1.94	27	RC-258
2.56	2.25	1.00	2.00	.41	1 1/2"-16	1.00	2.31	1/2"-13UN	.75	3 5/16"-12	1.94	31	RC-2510
2.56	2.25	1.00	2.00	.41	1 1/2"-16	1.00	2.31	1/2"-13UN	.75	3 5/16"-12	1.94	36	RC-2512
2.56	2.25	1.00	2.00	.41	1 1/2"-16	1.00	2.31	1/2"-13UN	.75	3 5/16"-12	1.94	39	RC-2514*
2.88	2.25	2.25	2.00	.41	1 1/2"-16	1.00	—	—	—	3 5/16"-12	1.94	40	RC-308
3.75	3.13	1.31	2.81	.11	—	—	3.75	1/2"-13UN	.75	5"-12	2.19	33	RC-502
3.75	3.13	1.31	2.81	.11	—	—	3.75	1/2"-13UN	.75	5"-12	2.19	42	RC-504
3.75	3.13	1.38	2.81	.11	—	—	3.75	1/2"-13UN	.75	5"-12	2.19	51	RC-506*
3.75	3.13	1.38	2.81	.11	—	—	3.75	1/2"-13UN	.75	5"-12	2.19	83	RC-5013
4.50	3.75	1.19	2.81	.23	—	—	—	—	—	5 3/4"-12	1.75	65	RC-756
4.50	3.75	1.19	2.81	.23	—	—	—	—	—	5 3/4"-12	1.75	130	RC-7513
5.13	4.13	1.63	2.81	.11	—	—	5.50	3/4"-10UN	1.00	6 7/8"-12	1.75	130	RC-1006
5.13	4.13	1.63	2.81	.11	—	—	5.50	3/4"-10UN	1.00	6 7/8"-12	1.75	160	RC-10010

▼ SELECTION CHART

For Use with Cylinder Capacity (tons)	Saddles			Base Plate	Mounting Block	Clevis Eyes	
	Flat	Grooved ¹⁾	Tilt			Base ⁴⁾	Plunger
							
5	A-53F ²⁾	A-53G ²⁾	–	–	RB-5 ²⁾ , AW-51 ²⁾ , AW-53 ²⁾	REB-5 ²⁾	REP-5 ²⁾
10	A-12 ³⁾ , A-102F ³⁾	A-102G ³⁾	CAT-10 ³⁾	JB-I-10	RB-10, AW-102	REB-10	REP-10 ³⁾
15	–	A-152G	CAT-10	–	RB-15	REB-15	REP-10
25	A-29	A-252G	CAT-50	JB-I-25	RB-25	REB-25	REP-25
30	A-29	A-252G	CAT-50	–	RB-25	–	REP-25
50	–	–	CAT-100	JB-I-50	–	–	–
75	–	–	CAT-100	–	–	–	–
100	–	–	CAT-100	–	–	–	–

¹⁾ Standard on 5-30 ton RC-cylinders ²⁾ Except RC-50 ³⁾ Except RC-101 ⁴⁾ Mounting screws are included.

▼ DIMENSION CHARTS

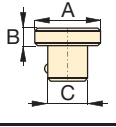
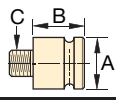
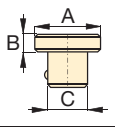
Model Number	Saddle Dimensions (in)			
	A	B	C	
Flat				
A-53F	1.00	.25	.68	
A-102F	1.38	.24	.88	
A-12	2.00	1.88	1"–8UNC	
A-29	2.00	1.88	1½"–16UN	
Grooved				
A-53G	1.00	.25	.68	
A-102G	1.38	.24	.88	
A-152G	1.50	.37	.88	
A-252G	1.97	.37	1.40	

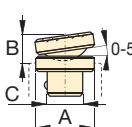
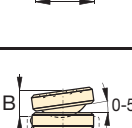
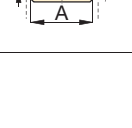
Model Number	Tilt Saddle Dimensions (in)			
	A	B	C	
Tilt				
CAT-10	1.38	.79	.88	
CAT-50	1.97	.83	1.40	
Tilt				
CAT-100	2.80	.98	–	

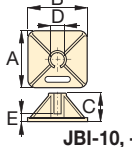
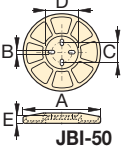
Model Number	Base Plate Dimensions (in)						
	A	B	C	D	E		
JB-I-10	9.00	9.00	5.34	2.29	.81	JB-I-10, -25	JB-I-50
JB-I-25	11.00	11.00	5.53	3.41	1.03		
JB-I-50	12.00	.60	3.75	5.19	1.25		

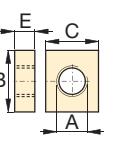
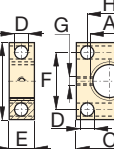
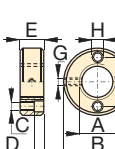
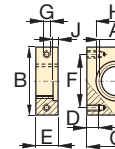
Model Number	Mounting Block Dimensions (in)											
	A	B	C	D	E	F	G	H				
RB-5	1½"–16	3.50	3.00	–	1.00	–	–	–	RB-5, -10	AW-51	AW-53	AW-102 (J=.19)
AW-51	1½"–16	2.76	2.36	.43	.98	2.13	¼"–20	1.62				
AW-53	1½"–16	2.87	.28	.31	.75	2.25	¼"–20	.41				
RB-10	2¼"–14	4.50	3.50	–	1.00	–	–	–				
AW-102	2¼"–14	3.94	3.25	.63	1.18	3.00	7/16"–20	2.31				
RB-15	2¾"–16	4.00	4.50	–	1.50	–	–	–				
RB-25	3⅞"–12	5.00	6.50	–	2.00	–	–	–				

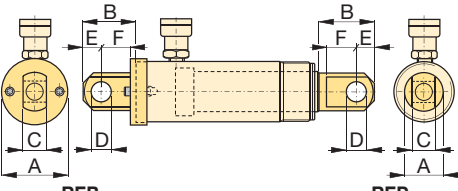
Type	Model Number	Clevis Eye Dimensions (in)						Pin to Pin* (in)	
		A	B	C	D	E	F		
Base ⁴⁾	REB-5	1.75	1.88	.56	.63	.63	1.00	2.37	
	REB-10	2.50	2.63	1.00	.88	1.00	1.38	3.07	
	REB-15	3.00	2.63	1.00	.88	1.00	1.38	3.07	
	REB-25	3.75	3.13	1.50	1.25	1.25	1.63	3.45	
Plunger	REP-5	1.13	1.75	.56	.63	.63	.75	–	
	REP-10	1.69	2.43	1.00	.88	1.00	1.13	–	
	REP-25	2.25	2.81	1.50	1.25	1.25	1.38	–	

* Pin to Pin– REB and REP Clevises fitted. Add cylinder collapsed height.

⁴⁾ Mounting screws are included.

The Enerpac Lightweight Aluminum Cylinders

▼ Shown: RAC, RACL, RACH, and RAR



RA Series

Capacity:
20-150 tons

Stroke:
1.97-9.84 inches

Maximum Operating Pressure:
10,000 psi



Think Safety
Manufacturer's rating of load and stroke are maximum safe limits.

Good practice encourages using only 80% of these ratings!

Page: 242

- Lightweight, easy to carry and position to allow a higher cylinder capacity-to-weight-ratio
- Non-corrosive by design, aluminum has always been a good material for use in many caustic environments
- Composite bearings on all moving surfaces guarantee **NO** metal-to-metal contact, to resist side loads and increase cylinder life



Aluminum vs. Steel

Aluminum cylinders, while offering the most lightweight solution also have some unique limitations due to material properties. It differs from steel in that it has a lower finite fatigue life. Aluminum cylinders should **NOT** be used in high-cycle applications such as production.

These cylinders are designed to provide 5000 cycles at their recommended pressure. **This limit should not be exceeded.** In normal lifting and many maintenance applications, this should provide a lifetime of use.

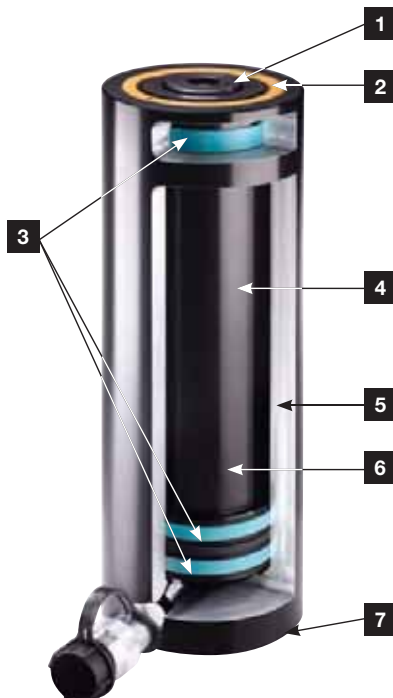

1. **Removable Hardened Saddle** protects plunger from being damaged by abrasive surface contact.
2. **Stop Ring** on all models absorbs eccentric loading and prevents plunger over-extension.
3. **Composite Bearing** material to prevent metal-to-metal contact, reducing side-load issues and increasing life.
4. **Hard-coated Plunger and Base** resist wear and prevent galling.
5. **7075-T6 Aluminum Alloy Components** for maximum strength and minimum weight.
6. **Plunger Return Spring** on all single-acting models for prompt cylinder return.
7. **Standard Steel Base Plate** protects cylinder base from abrasive surfaces.

▼ Shown from left to right: RAC-508, RAC-1506, RAC-304, and RAC-206



Lightweight for Maximum Portability



Saddles

All RAC cylinders are equipped with bolt-on removable saddles of hardened steel.



Lightweight Hand Pumps

Enerpac hand pumps **P-392** or **P-802** make the optimal lightweight set.

Page: **58**

- Composite bearings prevent metal-to-metal contact, increasing cylinder life and resistance to side-loads of up to 10%
- Hard coat finish on all surfaces resists damage and extends cylinder life
- Handles included on all models
- Steel baseplate and saddle for protection against load-induced damage
- Integral stop ring prevents plunger over-travel and is capable of withstanding the full cylinder capacity
- High-strength return spring for rapid cylinder retraction
- CR-400 coupler and dustcap included on all models
- All cylinders meet ASME B-30.1 and ISO 10100 standards



◀ Enerpac lightweight aluminum RAC-506 cylinders are ideal for wet environments such as this tunnel under the river (Holland High-Speed Train Line).

Cylinder Capacity	Stroke*	Model Number	Cylinder Effective Area
tons (maximum)	(in)		(in ²)
20 (24.2)	1.97	RAC-202	4.83
	3.94	RAC-204	4.83
	5.91	RAC-206	4.83
	7.87	RAC-208	4.83
	9.84	RAC-2010	4.83
30 (34.2)	1.97	RAC-302	6.85
	3.94	RAC-304	6.85
	5.91	RAC-306	6.85
	7.87	RAC-308	6.85
	9.84	RAC-3010	6.85
50 (54.9)	1.97	RAC-502	10.99
	3.94	RAC-504	10.99
	5.91	RAC-506	10.99
	7.87	RAC-508	10.99
	9.84	RAC-5010	10.99
100 (110.9)	1.97	RAC-1002	22.19
	3.94	RAC-1004	22.19
	5.91	RAC-1006	22.19
	7.87	RAC-1008	22.19
	9.84	RAC-10010	22.19
150 (175.9)	1.97	RAC-1502	35.18
	3.94	RAC-1504	35.18
	5.91	RAC-1506	35.18
	7.87	RAC-1508	35.18
	9.84	RAC-15010	35.18

* Custom strokes available.

Single-Acting, Spring Return Cylinders



Steel Base Plate

The steel base plate protects the cylinder base from damage, it should not be removed.

The base holes in these aluminum cylinders are designed for securing the steel base plate. **They will not withstand the capacity of the cylinder.**

Do not use the base holes in these aluminum cylinders to attach any device to the cylinder.

Capacity:

20-150 tons

Stroke:

1.97-9.84 inches

Maximum Operating Pressure:

10,000 psi

RAC Series



Optional Bolt-on Tilt Saddle Dimensions (in)

Cylinder Model / Capacity (ton)	Model Number*	Saddle Diameter J1	Saddle Protrusion from Plunger K1
RAC-50	CATG-50	1.95	1.02
RAC-100	CATG-150	3.57	1.30
RAC-150	CATG-200	4.64	1.44

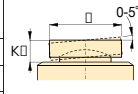

* Tilt saddle not available for less than 50 ton.

Steel Base Plate Mounting Holes

Cylinder Model / Capacity (ton)	Bolt Circle U (in)	Thread V (mm)	Thread Depth ¹⁾ Z (in)
RAC-20	2.76	M6	.47
RAC-30	3.15	M6	.47
RAC-50	4.33	M6	.47
RAC-100	5.91	M10	.47
RAC-150	7.87	M10	.47

¹⁾ Including Base Plate Height of .25 inches. Four (4) base plate bolts included.

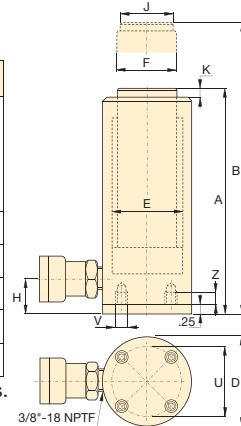

Oil Capacity (in ³)	Collapsed Height A (in)	Extended Height B (in)	Outside Diameter D (in)	Cylinder Bore Diameter E (in)	Plunger Diameter F (in)	Base to Advance Port H (in)	Saddle Diameter J (in)	Saddle Protrusion from Plunger K (in)	Weight (lbs)	Model Number
9.52	6.86	8.83	3.35	2.48	1.97	1.07	1.58	0.12	7.9	RAC-202
19.03	8.83	12.76	3.35	2.48	1.97	1.07	1.58	0.12	9.0	RAC-204
28.55	10.80	16.70	3.35	2.48	1.97	1.07	1.58	0.12	10.1	RAC-206
38.01	12.76	20.64	3.35	2.48	1.97	1.07	1.58	0.12	11.2	RAC-208
47.53	14.73	24.58	3.35	2.48	1.97	1.07	1.58	0.12	12.3	RAC-2010
13.49	7.13	9.10	3.94	2.95	2.36	1.31	1.58	0.12	9.9	RAC-302
26.99	9.10	13.04	3.94	2.95	2.36	1.31	1.58	0.12	11.5	RAC-304
40.48	11.07	16.98	3.94	2.95	2.36	1.31	1.58	0.12	13.0	RAC-306
53.91	13.04	20.91	3.94	2.95	2.36	1.31	1.58	0.12	14.5	RAC-308
67.40	15.01	24.85	3.94	2.95	2.36	1.31	1.58	0.12	16.1	RAC-3010
21.65	7.33	9.90	5.12	3.74	3.15	1.19	1.97	0.12	18.7	RAC-502
43.30	9.30	13.24	5.12	3.74	3.15	1.19	1.97	0.12	21.6	RAC-504
64.95	11.27	17.17	5.12	3.74	3.15	1.19	1.97	0.12	24.5	RAC-506
86.49	13.24	21.11	5.12	3.74	3.15	1.19	1.97	0.12	27.3	RAC-508
108.14	15.21	25.05	5.12	3.74	3.15	1.19	1.97	0.12	30.2	RAC-5010
43.71	8.71	10.68	7.09	5.32	4.33	1.82	3.70	0.12	38.1	RAC-1002
87.43	10.68	14.61	7.09	5.32	4.33	1.82	3.70	0.12	43.2	RAC-1004
131.14	12.65	18.55	7.09	5.32	4.33	1.82	3.70	0.12	48.3	RAC-1006
174.64	14.61	22.49	7.09	5.32	4.33	1.82	3.70	0.12	53.4	RAC-1008
218.35	16.58	26.43	7.09	5.32	4.33	1.82	3.70	0.12	58.4	RAC-10010
69.30	9.56	11.53	9.06	6.69	5.51	2.02	4.45	0.12	55.8	RAC-1502
138.61	11.53	15.47	9.06	6.69	5.51	2.02	4.45	0.12	64.6	RAC-1504
207.91	13.50	19.41	9.06	6.69	5.51	2.02	4.45	0.12	73.4	RAC-1506
276.87	15.47	23.34	9.06	6.69	5.51	2.02	4.45	0.12	82.2	RAC-1508
346.17	17.44	27.28	9.06	6.69	5.51	2.02	4.45	0.12	91.1	RAC-15010

▼ Shown from left to right: RACL-1006, RACL-504 and RACL-506



- Aluminum Lock Nut provides mechanical load holding for extended periods
- Hardened steel stop ring increases cylinder life and resistance to side-loads of up to 5%
- Hard coat finish on all surfaces resists damage and extends cylinder life
- Composite bearings increase cylinder life and side load resistance
- Handles included on all models
- Steel base plate and saddle for protection against load-induced damage
- Integral stop ring prevents plunger over-travel and is capable of withstanding the full cylinder capacity
- High-strength return spring for rapid cylinder retraction
- CR-400 coupler and dustcap included on all models
- All cylinders meet ASME B-30.1 and ISO 10100 standards



◀ The portable Lock Nut cylinder RACL-1506 used for extended load support during epoxy injection for bridge reinforcement.

To Secure Loads Mechanically



Saddles

All RACL cylinders are equipped with bolt-on removable saddles of hardened steel. For tilt saddles see next page.

Page: 15



Hoses

Enerpac offers a complete line of high-quality hydraulic hoses. To ensure the integrity of your system, specify only Enerpac hydraulic hoses.

Page: 114

Cylinder Capacity	Stroke*	Model Number	Cylinder Effective Area
ton (maximum)	(in)		(in ²)
20 (24.2)	1.97	RACL-202	4.83
	3.94	RACL-204	4.83
	5.91	RACL-206	4.83
	7.87	RACL-208	4.83
	9.84	RACL-2010	4.83
30 (34.2)	1.97	RACL-302	6.85
	3.94	RACL-304	6.85
	5.91	RACL-306	6.85
	7.87	RACL-308	6.85
	9.84	RACL-3010	6.85
50 (54.9)	1.97	RACL-502	10.99
	3.94	RACL-504	10.99
	5.91	RACL-506	10.99
	7.87	RACL-508	10.99
	9.84	RACL-5010	10.99
100 (110.9)	1.97	RACL-1002	22.19
	3.94	RACL-1004	22.19
	5.91	RACL-1006	22.19
	7.87	RACL-1008	22.19
	9.84	RACL-10010	22.19
150 (175.9)	1.97	RACL-1502	35.18
	3.94	RACL-1504	35.18
	5.91	RACL-1506	35.18
	7.87	RACL-1508	35.18
	9.84	RACL-15010	35.18

* Custom strokes available.

Single-Acting, Spring Return, Lock Nut Cylinders



Steel Base Plate

The steel base plate protects the cylinder base from damage, it should not be removed.

The base holes in these aluminum cylinders are designed for securing the steel base plate. **They will not withstand the capacity of the cylinder.**

Do not use the base holes in these aluminum cylinders to attach any device to the cylinder.

Capacity:

20-150 tons

Stroke:

1.97-9.84 inches

Maximum Operating Pressure:

10,000 psi

RACL Series



Optional Bolt-on Tilt Saddle Dimensions (in)

Cylinder Model / Capacity (ton)	Model Number*	Saddle Diameter J1	Saddle Protrusion from Plunger K1
RACL-50	CATG-50	1.95	1.02
RACL-100	CATG-150	3.57	1.30
RACL-150	CATG-200	4.64	1.44

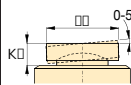

* Tilt saddle not available for less than 50 ton.

Steel Base Plate Mounting Holes

Cylinder Model / Capacity (ton)	Bolt Circle U (in)	Thread V (mm)	Thread Depth ¹⁾ Z (in)
RACL-20	2.76	M6	.47
RACL-30	3.15	M6	.47
RACL-50	4.33	M6	.47
RACL-100	5.91	M10	.47
RACL-150	7.87	M10	.47

¹⁾ Including Base Plate Height of .25 inches. Four (4) base plate bolts included.

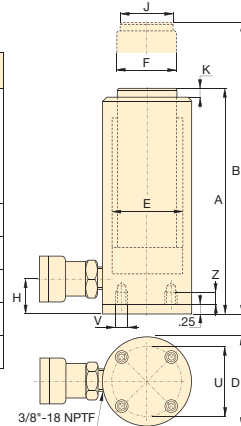

Oil Capacity (in ³)	Collapsed Height A (in)	Extended Height B (in)	Outside Diameter D (in)	Cylinder Bore Diameter E (in)	Plunger Diameter (Threaded) F (in)	Base to Advance Port H (in)	Saddle Diameter J (in)	Saddle Protrusion from Plunger K (in)	Lock Nut Height S (in)	Weight (lbs)	Model Number
9.52	8.83	10.80	3.35	2.48	2.17	1.07	1.58	0.12	1.97	8.8	RACL-202
19.03	10.80	14.73	3.35	2.48	2.17	1.07	1.58	0.12	1.97	10.1	RACL-204
28.55	12.76	18.67	3.35	2.48	2.17	1.07	1.58	0.12	1.97	11.4	RACL-206
38.01	14.73	22.61	3.35	2.48	2.17	1.07	1.58	0.12	1.97	12.7	RACL-208
47.53	16.70	26.54	3.35	2.48	2.17	1.07	1.58	0.12	1.97	14.1	RACL-2010
13.49	9.10	11.07	3.94	2.95	2.36	1.31	1.58	0.12	1.97	11.9	RACL-302
26.99	11.07	15.01	3.94	2.95	2.36	1.31	1.58	0.12	1.97	13.4	RACL-304
40.48	13.04	18.95	3.94	2.95	2.36	1.31	1.58	0.12	1.97	14.9	RACL-306
53.91	15.01	22.88	3.94	2.95	2.36	1.31	1.58	0.12	1.97	16.5	RACL-308
67.40	16.98	26.82	3.94	2.95	2.36	1.31	1.58	0.12	1.97	18.0	RACL-3010
21.65	9.30	11.27	5.12	3.74	3.15	1.19	1.97	0.12	2.95	20.5	RACL-502
43.30	11.27	15.21	5.12	3.74	3.15	1.19	1.97	0.12	2.95	23.4	RACL-504
64.95	13.24	19.14	5.12	3.74	3.15	1.19	1.97	0.12	2.95	26.2	RACL-506
86.49	15.20	23.08	5.12	3.74	3.15	1.19	1.97	0.12	2.95	29.1	RACL-508
108.14	17.17	27.02	5.12	3.74	3.15	1.19	1.97	0.12	2.95	31.9	RACL-5010
43.71	11.66	13.63	7.09	5.32	4.33	1.82	3.70	0.12	2.95	48.2	RACL-1002
87.43	13.63	17.57	7.09	5.32	4.33	1.82	3.70	0.12	2.95	53.3	RACL-1004
131.14	15.60	21.50	7.09	5.32	4.33	1.82	3.70	0.12	2.95	58.4	RACL-1006
174.64	17.57	25.44	7.09	5.32	4.33	1.82	3.70	0.12	2.95	63.4	RACL-1008
218.35	19.54	29.38	7.09	5.32	4.33	1.82	3.70	0.12	2.95	68.5	RACL-10010
69.30	12.71	14.68	9.06	6.69	5.51	2.02	4.45	0.12	3.15	71.0	RACL-1502
138.61	14.68	18.62	9.06	6.69	5.51	2.02	4.45	0.12	3.15	79.8	RACL-1504
207.91	16.65	22.56	9.06	6.69	5.51	2.02	4.45	0.12	3.15	88.6	RACL-1506
276.87	18.62	26.49	9.06	6.69	5.51	2.02	4.45	0.12	3.15	97.4	RACL-1508
346.17	20.59	30.43	9.06	6.69	5.51	2.02	4.45	0.12	3.15	106.3	RACL-15010

▼ Shown from left to right: RACH-1508, RACH-304 and RACH-208



The Lightweight Solution for Tensioning and Testing



Saddles

All RACH-cylinders are equipped with bolt-on removable hardened steel hollow saddles.



Lightweight Hand Pumps

Enerpac hand pumps **P-392** or **P-802** make the optimal lightweight set.

Page: 58

- Hollow plunger design allows for both pull and push forces
- Composite bearings increase cylinder life and side load resistance
- Hard coat finish on all surfaces resists damage and extends cylinder life
- Handles included on all models
- Floating center tube increases seal life
- Steel baseplate and saddle for protection against load-induced damage
- Integral stop ring prevents plunger over-travel and is capable of withstanding the full cylinder capacity
- High-strength return spring for rapid cylinder retraction



◀ An RACH-306, powered by a P-392 hand pump, is used to extract corroded carriage pins from refuse collection vehicles.

Cylinder Capacity tons (maximum)	Stroke* (in)	Model Number	Cylinder Effective Area (in ²)
20 (25.4)	1.97	RACH-202	5.07
	3.94	RACH-204	5.07
	5.91	RACH-206	5.07
	7.87	RACH-208	5.07
	9.84	RACL-2010	5.07
30 (39.6)	1.97	RACH-302	7.92
	3.94	RACH-304	7.92
	5.91	RACH-306	7.92
	7.87	RACH-308	7.92
	9.84	RACH-3010	7.92
60 (65.6)	1.97	RACH-602	13.13
	3.94	RACH-604	13.13
	5.91	RACH-606	13.13
	7.87	RACH-608	13.13
	9.84	RACH-6010	13.13
100 (127.5)	1.97	RACH-1002	25.51
	3.94	RACH-1004	25.51
	5.91	RACH-1006	25.51
	7.87	RACH-1008	25.51
	9.84	RACH-10010	25.51
150 (175.0)	1.97	RACH-1502	35.00
	3.94	RACH-1504	35.00
	5.91	RACH-1506	35.00
	7.87	RACH-1508	35.00
	9.84	RACH-15010	35.00

* Custom strokes available.

Single-Acting, Spring Return, Hollow Plunger Cylinders



Steel Base Plate

The steel base plate protects the cylinder base from damage, it should not be removed.

The base holes in these aluminum cylinders are designed for securing the steel base plate. **They will not withstand the capacity of the cylinder.**

Do not use the base holes in these aluminum cylinders to attach any device to the cylinder.

RACH Series



Capacity:

20-150 tons

Stroke:

1.97-9.84 inches

Center Hole Diameter:

1.06-3.11 inches

Maximum Operating Pressure:

10,000 psi

Steel Base Plate Mounting Holes			
Cylinder Model / Capacity (ton)	Bolt Circle U (in)	Thread V (mm)	Thread Depth ¹⁾ Z (in)
RACH-20	3.15	M6	.47
RACH-30	4.33	M6	.47
RACH-60	6.30	M6	.47
RACH-100	8.66	M10	.47
RACH-150	9.65	M10	.47

¹⁾ Including Base Plate Height of .25 inches.
Four (4) baseplate bolts included.

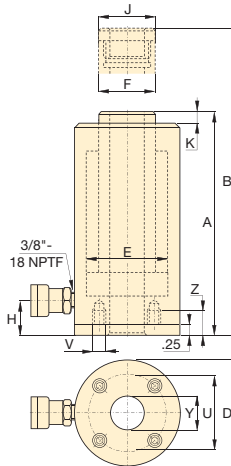

Oil Capacity (in ³)	Collapsed Height A (in)	Extended Height B (in)	Outside Diameter D (in)	Cylinder Bore Diameter E (in)	Plunger Diameter F (in)	Base to Advance Port G (in)	Saddle Diameter H (in)	Saddle Protrusion from Plunger I (in)	Center Hole Diameter J (in)	Weight (lbs)	Model Number
9.98	7.41	9.38	3.93	2.95	2.17	1.14	2.17	0.40	1.06	11.5	RACH-202
19.96	9.89	13.83	3.93	2.95	2.17	1.14	2.17	0.40	1.06	13.5	RACH-204
29.94	12.41	18.32	3.93	2.95	2.17	1.14	2.17	0.40	1.06	15.6	RACH-206
39.87	14.89	22.76	3.93	2.95	2.17	1.14	2.17	0.40	1.06	17.7	RACH-208
49.90	17.41	27.25	3.93	2.95	2.17	1.14	2.17	0.40	1.06	19.8	RACH-210
15.59	8.20	10.17	5.12	3.74	2.76	1.14	2.76	0.40	1.34	17.6	RACH-302
31.18	10.52	14.46	5.12	3.74	2.76	1.14	2.76	0.40	1.34	20.9	RACH-304
46.77	13.12	19.02	5.12	3.74	2.76	1.14	2.76	0.40	1.34	24.6	RACH-306
62.35	15.56	23.43	5.12	3.74	2.76	1.14	2.76	0.40	1.34	28.4	RACH-308
77.94	18.04	27.88	5.12	3.74	2.76	1.14	2.76	0.40	1.34	31.9	RACH-310
25.84	9.89	11.86	7.09	5.12	3.94	2.41	3.94	0.47	2.13	35.6	RACH-602
51.69	12.41	16.35	7.09	5.12	3.94	2.41	3.94	0.47	2.13	42.8	RACH-604
77.53	14.97	20.87	7.09	5.12	3.94	2.41	3.94	0.47	2.13	50.3	RACH-606
103.37	17.52	25.40	7.09	5.12	3.94	2.41	3.94	0.47	2.13	57.2	RACH-608
129.21	20.09	29.93	7.09	5.12	3.94	2.41	3.94	0.47	2.13	65.1	RACH-6010
50.21	10.16	12.13	9.84	7.28	5.71	2.41	5.71	0.55	3.11	74.6	RACH-1002
100.43	12.80	16.74	9.84	7.28	5.71	2.41	5.71	0.55	3.11	87.8	RACH-1004
150.64	15.40	21.31	9.84	7.28	5.71	2.41	5.71	0.55	3.11	101.9	RACH-1006
200.85	18.08	25.95	9.84	7.28	5.71	2.41	5.71	0.55	3.11	115.7	RACH-1008
251.07	20.76	30.60	9.84	7.28	5.71	2.41	5.71	0.55	3.11	129.3	RACH-10010
66.08	11.03	13.00	10.83	8.07	5.91	2.41	5.91	0.55	3.11	107.7	RACH-1502
132.17	14.18	18.12	10.83	8.07	5.91	2.41	5.91	0.55	3.11	122.8	RACH-1504
206.72	16.93	22.84	10.83	8.07	5.91	2.41	5.91	0.55	3.11	138.9	RACH-1506
275.62	19.69	27.57	10.83	8.07	5.91	2.41	5.91	0.55	3.11	154.5	RACH-1508
344.53	22.45	32.29	10.83	8.07	5.91	2.41	5.91	0.55	3.11	170.2	RACH-15010

▼ Shown from left to right: RAR-506, RAR-508, RAR-302



The Lightweight Solution for Double-Acting Applications



Saddles

All RAR-cylinders are equipped with bolt-on removable hardened steel saddles. For tilt saddles see next page.

Page: 19



Hoses

Enerpac offers a complete line of high-quality hydraulic hoses. To ensure the integrity of your system, specify only Enerpac hydraulic hoses.

Page: 114

- Double-acting for rapid retraction, regardless of hose lengths and system losses
- Composite bearings increase cylinder life and side load resistance
- Hard coat finish on all surfaces resists damage and extends cylinder life
- Handles included on all models
- Steel base plate and saddle for protection against load-induced damage
- Integral stop ring prevents plunger over-travel and is capable of withstanding the full cylinder capacity
- Built-in safety valve prevents accidental over-pressurization



◀ An RAR-506 was easy to position under a bulldozer for repair of frame member.

Cylinder Capacity (ton)	Stroke* (in)	Model Number	Maximum Cylinder Capacity (ton)		Cylinder Effective Area (in ²)		Oil Capacity (in ³)	
			Push	Pull	Push	Pull	Push	Pull
20 (24.2)	1.97	RAR-202	24.2	14.4	4.83	2.88	9.52	5.67
	3.94	RAR-204	24.2	14.4	4.83	2.88	19.03	11.34
	5.91	RAR-206	24.2	14.4	4.83	2.88	28.55	17.02
	7.87	RAR-208	24.2	14.4	4.83	2.88	38.01	22.66
	9.84	RAR-2010	24.2	14.4	4.83	2.88	47.53	28.34
30 (34.2)	1.97	RAR-302	34.2	19.0	6.85	3.80	13.49	7.49
	3.94	RAR-304	34.2	19.0	6.85	3.80	26.99	14.97
	5.91	RAR-306	34.2	19.0	6.85	3.80	40.48	22.46
	7.87	RAR-308	34.2	19.0	6.85	3.80	53.91	29.91
	9.84	RAR-3010	34.2	19.0	6.85	3.80	67.40	37.39
50 (54.9)	1.97	RAR-502	54.9	17.1	10.99	3.54	21.65	6.97
	3.94	RAR-504	54.9	17.1	10.99	3.54	43.30	13.95
	5.91	RAR-506	54.9	17.1	10.99	3.54	64.95	20.92
	7.87	RAR-508	54.9	17.1	10.99	3.54	86.49	27.86
	9.84	RAR-5010	54.9	17.1	10.99	3.54	108.14	34.83
100 (110.9)	1.97	RAR-1002	110.9	61.7	22.19	12.33	43.71	24.29
	3.94	RAR-1004	110.9	61.7	22.19	12.33	87.43	48.58
	5.91	RAR-1006	110.9	61.7	22.19	12.33	131.14	72.87
	7.87	RAR-1008	110.9	61.7	22.19	12.33	174.64	97.04
	9.84	RAR-10010	110.9	61.7	22.19	12.33	218.35	121.33
150 (175.9)	1.97	RAR-1502	175.9	102.25	35.18	20.45	69.30	40.29
	3.94	RAR-1504	175.9	102.25	35.18	20.45	138.61	80.57
	5.91	RAR-1506	175.9	102.25	35.18	20.45	207.91	120.86
	7.87	RAR-1508	175.9	102.25	35.18	20.45	276.87	160.94
	9.84	RAR-15010	175.9	102.25	35.18	20.45	346.17	201.23

* Custom strokes available.

Double-Acting, Aluminum Cylinders



Steel Base Plate

The steel base plate protects the cylinder base from damage, it should not be removed.

The base holes in these aluminum cylinders are designed for securing the steel base plate. **They will not withstand the capacity of the cylinder.**

Do not use the base holes in these aluminum cylinders to attach any device to the cylinder.

Capacity:
20-150 tons

Stroke:
1.97-9.84 inches

Maximum Operating Pressure:
10,000 psi

RAR Series



Optional Bolt Tilt Saddle Dimensions (in)

Cylinder Model / Capacity (ton)	Model Number*	Saddle Diameter J1	Saddle Protrusion from Plunger K1
RAR-50	CATG-50	1.95	1.02
RAR-100	CATG-100	2.81	1.22
RAR-150	CATG-150	3.57	1.30

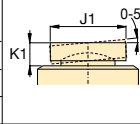

* Tilt saddle not available for less than 50 ton.

Steel Base Plate Mounting Holes

Cylinder Model / Capacity (ton)	Bolt Circle U (in)	Thread V (mm)	Thread Depth ¹⁾ Z (in)
RAR-20	3.66	M6	.47
RAR-30	4.13	M6	.47
RAR-50	4.33	M6	.47
RAR-100	6.10	M10	.47
RAR-150	7.87	M10	.47

¹⁾ Including Base Plate Height of .25 inches. Four (4) base plate bolts included.

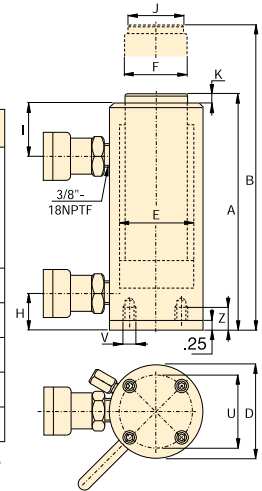

Collapsed Height	Extended Height	Outside Diameter	Cylinder Bore Diameter	Plunger Diameter	Base to Advance Port	Top to Retract Port	Saddle Diameter	Saddle Protrusion from Plunger	Weight	Model Number
A (in)	B (in)	D (in)	E (in)	F (in)	H (in)	I (in)	J (in)	K (in)	(lbs)	
7.45	9.42	4.45	2.48	1.58	1.19	1.97	1.18	0.12	16.3	RAR-202
9.42	13.35	4.45	2.48	1.58	1.19	1.97	1.18	0.12	17.6	RAR-204
11.29	17.29	4.45	2.48	1.58	1.19	1.97	1.18	0.12	19.0	RAR-206
13.35	21.23	4.45	2.48	1.58	1.19	1.97	1.18	0.12	20.3	RAR-208
15.32	25.17	4.45	2.48	1.58	1.19	1.97	1.18	0.12	21.6	RAR-2010
7.92	9.89	4.92	2.95	1.97	1.19	2.17	1.58	0.12	19.0	RAR-302
9.89	13.83	4.92	2.95	1.97	1.19	2.17	1.58	0.12	20.9	RAR-304
11.86	17.76	4.92	2.95	1.97	1.19	2.17	1.58	0.12	22.9	RAR-306
13.83	21.70	4.92	2.95	1.97	1.19	2.17	1.58	0.12	24.9	RAR-308
15.80	25.64	4.92	2.95	1.97	1.19	2.17	1.58	0.12	26.9	RAR-3010
7.92	9.89	5.71	3.74	2.95	1.19	2.21	1.97	0.12	24.5	RAR-502
9.89	13.83	5.71	3.74	2.95	1.19	2.21	1.97	0.12	28.0	RAR-504
11.86	17.76	5.71	3.74	2.95	1.19	2.21	1.97	0.12	31.5	RAR-506
13.83	21.70	5.71	3.74	2.95	1.19	2.21	1.97	0.12	35.1	RAR-508
15.80	25.64	5.71	3.74	2.95	1.19	2.21	1.97	0.12	38.6	RAR-5010
9.89	11.86	7.28	5.32	3.54	1.70	3.15	2.95	0.12	36.2	RAR-1002
11.86	15.80	7.28	5.32	3.54	1.70	3.15	2.95	0.12	42.6	RAR-1004
13.83	19.73	7.28	5.32	3.54	1.70	3.15	2.95	0.12	48.9	RAR-1006
15.80	23.67	7.28	5.32	3.54	1.70	3.15	2.95	0.12	55.3	RAR-1008
17.76	27.61	7.28	5.32	3.54	1.70	3.15	2.95	0.12	61.7	RAR-10010
9.77	11.74	9.06	6.70	4.33	1.50	2.95	3.70	0.12	53.4	RAR-1502
11.74	16.68	9.06	6.70	4.33	1.50	2.95	3.70	0.12	63.7	RAR-1504
13.71	19.61	9.06	6.70	4.33	1.50	2.95	3.70	0.12	73.2	RAR-1506
15.68	23.55	9.06	6.70	4.33	1.50	2.95	3.70	0.12	83.6	RAR-1508
19.61	29.46	9.06	6.70	4.33	1.50	2.95	3.70	0.12	93.9	RAR-15010

▼ Shown from left to right: CLP-4002, CLP-5002



The Shortest Power Lifter

- Flat design for use in confined areas
- Safety lock nut for mechanical load holding
- Single-acting load return
- Special bearing design resists sideload forces
- Overflow port functions as a stroke limiter
- CR-400 coupler and dust cap included on all models



Saddles

All CLP-Series cylinders include integral tilt saddles with maximum tilt angles up to 5°.



Gauges

Minimize the risk of overloading and ensure long, dependable service from your equipment. Refer to the

System Components section for a full range of gauges.

Page: 113



Hoses

Enerpac offers a complete line of high-quality hydraulic hoses. To ensure the integrity of your system, specify only Enerpac hydraulic hoses.

Page: 114

▼ Only the extreme low height CLP-cylinder fits in this confined area to lift the construction. The V-82 needle valve is used to control cylinder speed during lifting and lowering.



Cylinder Capacity (ton) [maximum]	Stroke (in)	Model Number	Cylinder Effective Area (in ²)	Oil Capacity (in ³)
60 [67.1]	1.97	CLP-602	13.42	26.42
100 [113.7]	1.97	CLP-1002	22.75	44.78
160 [179.2]	1.77	CLP-1602	35.85	63.51
200 [221.3]	1.77	CLP-2002	44.27	78.43
250 [284.2]	1.77	CLP-2502	56.85	100.72
400 [433.6]	1.77	CLP-4002	86.72	153.64
500 [566.2]	1.77	CLP-5002	113.25	200.63

Single-Acting, Pancake Lock Nut Cylinders



Speed Chart

See the Enerpac Cylinder Speed Chart in our "Yellow Pages" to determine your approximate cylinder speed.

Page: 251



Longer Stroke Lock Nut Cylinders

For lock nut applications that require longer stroke lengths, see **CLL-Series** cylinders.

Page: 44

CLP Series



Capacity:

60-500 tons

Stroke:

1.77-1.97 inches

Maximum Operating Pressure:

10,000 psi

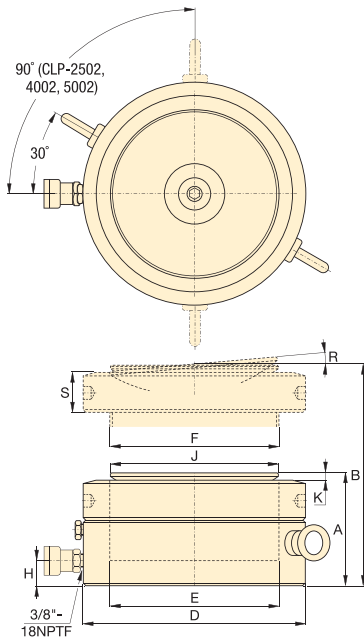

CLP-4002, CLP-5002

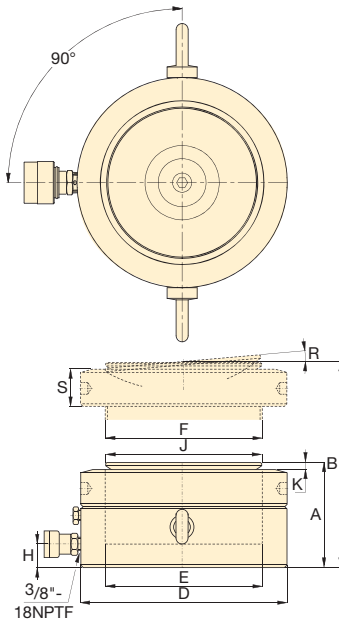

CLP-602, CLP-1002,
CLP-1602, CLP-2002,
CLP-2502



All CLP-series cylinders require a solid lifting surface for correct support.

Use of pancake cylinders on surfaces such as sand, mud or dirt may result in cylinder damage!

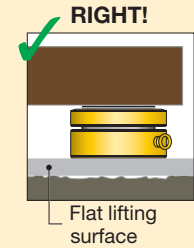

For more safety instructions see our "Yellow Pages".

Page: 241

Collapsed Height	Extended Height	Outside Diameter	Cyl. Bore Diameter	Plunger Diameter	Base to Advance Port	Saddle Diameter	Saddle Protrusion from Plunger	Saddle Max. Tilt Angle	Lock Nut Height	Weight	Model Number
A (in)	B (in)	D (in)	E (in)	F (mm)	H (in)	J (in)	K (in)	R	S (in)	(lbs)	
4.92	6.89	5.51	4.13	Tr 104 x 4	.75	3.78	.24	5°	1.10	33	CLP-602
5.39	7.36	6.89	5.38	Tr 136 x 6	.83	4.96	.31	5°	1.22	57	CLP-1002
5.83	7.60	8.66	6.76	Tr 171 x 6	1.06	6.30	.35	5°	1.57	97	CLP-1602
6.10	7.87	9.65	7.51	Tr 190 x 6	1.18	7.09	.39	5°	1.69	125	CLP-2002
6.26	8.03	10.83	8.51	Tr 216 x 6	1.26	7.87	.43	5°	1.73	163	CLP-2502
7.01	8.78	13.78	10.51	Tr 266 x 6	1.54	9.84	.43	4°	2.17	295	CLP-4002
7.56	9.33	15.75	12.01	Tr 305 x 6	1.89	11.42	.39	3°	2.44	416	CLP-5002

▼ Shown from left to right: RSM-1000, RSM-300, RSM-50, RCS-1002, RCS-302



Maximum Power to Height Ratio



Saddles

All **RCS-Series** cylinders have plunger mounting holes for installation of tilt saddles. See table for selection and dimensional information.

Page: **23**



Low Clearance Lifting

The **LW-16** Lifting Wedge and **SOH-Series** Machine Lifts are the perfect choices for lifting loads that have low clearance.

Page: **159**

RSM-Series, Flat-Jac® Cylinders

- Compact, flat design for use where other cylinders will not fit
- RSM-750, 1000 and 1500 have handles for easy carrying
- Mounting holes permit easy fixturing
- Baked enamel finish for increased corrosion resistance
- CR-400 coupler and dust cap included on all models*
- Hard chrome plated high-quality steel plungers
- Grooved plunger ends require no saddle
- Single-acting spring return

RCS-Series, Low Height Cylinders

- Lightweight, low profile design for use in confined spaces
- Baked enamel finish for increased corrosion resistance
- Plunger wiper reduces contamination, extending cylinder life
- CR-400 coupler and dust cap included on all models
- Grooved plunger end with threaded holes for mounting tilt saddles
- Integral handle on RCS-1002 for easy carrying
- Plated steel plungers
- Single-acting spring return

▼ Only a couple of inches are needed for an RSM-cylinder to lift this large steel construction.



Cylinder Capacity	Stroke	Model Number	Cyl. Effect. Area	Oil Cap.
(tons) [max.]	(in)		(in ²)	(in ³)
5 [4.9]	.25	RSM-50*	.99	.25
10 [11.2]	.44	RSM-100	2.24	.98
20 [22.1]	.44	RSM-200	4.43	1.94
30 [32.4]	.50	RSM-300	6.49	3.25
50 [48.1]	.63	RSM-500	9.62	6.01
75 [79.5]	.63	RSM-750	15.90	9.94
100 [98.1]	.63	RSM-1000	19.63	12.27
150 [153.4]	.63	RSM-1500	30.68	19.17
10 [11.2]	1.50	RCS-101**	2.24	3.35
20 [22.1]	1.75	RCS-201**	4.43	7.75
30 [32.4]	2.44	RCS-302**	6.49	15.82
50 [48.1]	2.38	RCS-502**	9.62	22.85
100 [98.1]	2.25	RCS-1002**	19.63	44.18

* RSM-50 is fitted with an AR-400 coupler.

** Available as a set. See note on next page.

Single-Acting, Low Height Cylinders

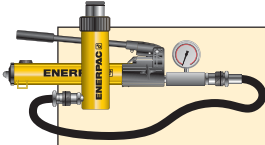

Pump and Cylinder Sets

All cylinders marked with an ** are available as sets (cylinder, gauge, couplers, hose and pump) for your ordering convenience.

Page: 54

Optional Bolt On Tilt Saddle Dimensions (in)

For cylinder model:	Model Number	A	B	C*
RCS-201, -302, -502	CAT-51	1.97	.59	1.14
RCS-1002	CAT-101	2.80	.67	1.39

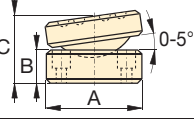

* "C" dimension equals saddle protrusion from plunger. Mounting screws are included.

RSM RCS Series



Capacity:
5-150 tons

Stroke:
.25-2.44 inches

Maximum Operating Pressure:
10,000 psi

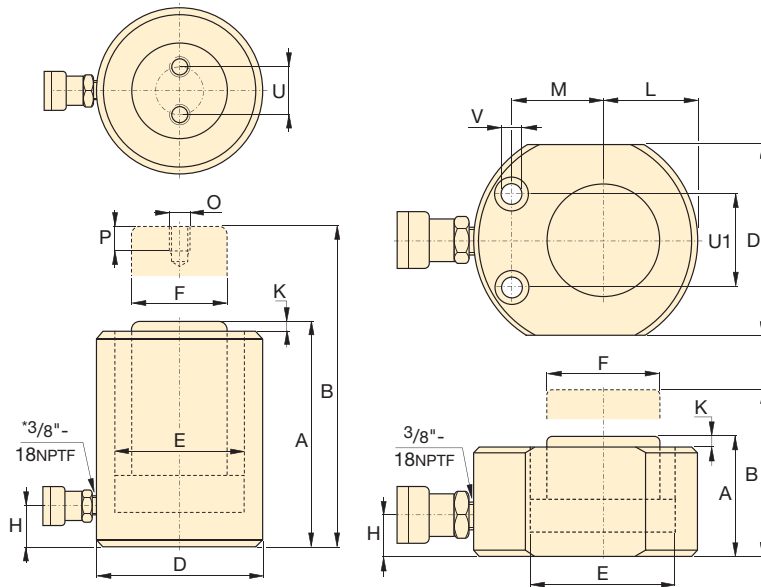

RCS-Series

RSM-Series

* 5° angle position of coupler on RCS-101, 201, 302.

RSM Cylinder Mounting Hole Dimensions (in)

Model Number	Hole Pitch U1	Hole Diam. V	Counter Bore Diam.	Counter Bore Depth
RSM-50	1.12	.20	.312	.17
RSM-100	1.44	.28	.422	.31
RSM-200	1.94	.40	.594	.39
RSM-300	2.06	.40	.625	.44
RSM-500	2.62	.47	.750	.50
RSM-750	3.00	.53	.812	.56
RSM-1000	3.00	.53	.812	.56
RSM-1500	4.62	.53	.812	.56

Collapsed Height	Extended Height	Outside Diameter	Cylinder Bore Diameter	Plunger Diameter	Base to Advance Port	Plunger Protrusion from Base	Plunger to Base	Plunger to Mtg. Hole	Thread	Thread Depth	Bolt Circle	Weight	Model Number
A (in)	B (in)	D (in)	E (in)	F (in)	H (in)	K (in)	L (in)	M (in)	O (mm)	P (in)	U (in)	(lbs)	
1.28	1.53	2.31 x 1.63	1.13	1.00	.63	.04	.81	.88	-	-	-	2.3	RSM-50*
1.69	2.13	3.25 x 2.19	1.69	1.50	.75	.04	1.09	1.34	-	-	-	3.1	RSM-100
2.03	2.47	4.00 x 3.00	2.38	2.00	.75	.04	1.56	1.56	-	-	-	6.8	RSM-200
2.31	2.81	4.63 x 3.75	2.88	2.50	.75	.08	1.88	1.75	-	-	-	10	RSM-300
2.63	3.25	5.50 x 4.50	3.50	2.75	.75	.08	2.25	2.13	-	-	-	15	RSM-500
3.13	3.75	6.50 x 5.50	4.50	3.25	.75	.08	2.75	2.63	-	-	-	25	RSM-750
3.38	4.00	7.00 x 6.00	5.00	3.63	.75	.08	3.00	2.94	-	-	-	32	RSM-1000
3.94	4.56	8.50 x 7.50	6.25	4.50	.94	.08	3.75	3.25	-	-	-	58	RSM-1500
3.47	4.97	2.75	1.69	1.50	.69	.20	-	-	M4	.32	1.03	9	RCS-101**
3.88	5.63	3.63	2.38	2.00	.69	.13	-	-	M5	.32	1.57	11	RCS-201**
4.63	7.06	4.00	2.88	2.62	.75	.13	-	-	M5	.32	1.57	15	RCS-302**
4.81	7.19	4.88	3.50	2.75	.94	.08	-	-	M5	.32	1.57	24	RCS-502**
5.56	7.81	6.50	5.00	3.63	1.25	.06	-	-	M8	.40	2.17	50	RCS-1002**

▼ Shown from left to right: BRC-25, BRC-46, BRP-306, BRP-606, BRP-106C



- High strength alloy steel construction
- Plunger blow-out protection to prevent over-extension
- Hard chrome-plated plunger for long life
- Baked enamel finish for increased corrosion resistance
- CR-400 coupler and dust cap included on all models
- Plunger wiper reduces contamination, extending cylinder life
- Single-acting spring-return
- Replaceable links on BRP-models

▼ Ship building, welding and Enerpac pull cylinders go hand in hand.



The Ultimate in Pulling Power

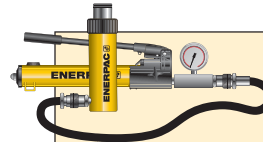

Pump and Cylinder Sets

All cylinders marked with an * are available as **sets** (cylinder, gauge, couplers, hose and pump) for your ordering convenience.

Page: 54



Gauges

Minimize the risk of over-loading and ensure long, dependable service from your equipment. Refer to the System Components section for a full range of gauges.

Page: 113



Attachments and Accessories

The BRC-25 and BRC-46 units have base, collar and plunger threads to affix a range of optional attachments and accessories, such as chains, saddles and extension tubes.

Page: 160

▼ To lift a load bearing mast into place, BRP cylinders were used to tension the supporting cables.



Single-Acting, Pull Cylinders

BRC Cylinder Mounting Dimensions (in)				
Model Number	Base Mounting Hole V	Collar Thread W	Collar Thread Length X	Mtg. Thread Length Z
BRC-25	3/4"-14 NPT	1 1/2"-16 UN	.98	.67
BRC-46	1 1/4"-11 1/2" NPT	2 1/4"-14 UN	1.06	.98
BRC-106	M30 x 2	M85 x 2	1.02	.98

**BRC
BRP
Series**



Capacity:
2.5-60 tons

Stroke:
5.00-6.00 inches

Maximum Operating Pressure:
10,000 psi

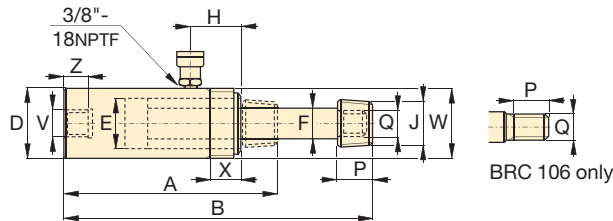

BRC-25 to BRC-106

Cylinder Capacity (tons) [maximum]	Stroke (in)	Model Number	Cyl. Effect. Area (in ²)	Oil Cap. (in ³)	Collap. Height A (in)	Ext. Height B (in)	Outside Diam. D (in)	Cyl. Bore Diam. E (in)	Plgr. Diam. F (in)	Top to Inlet Port H (in)	Saddle Diameter J (in)	Plunger Thread Length P (in)	Plunger Outside Thread Q	Weight (lbs)
2.5 [2.7]	5.00	BRC-25	.55	2.76	10.44	15.44	1.89	1.13	.75	1.77	3/4"-14 NPT	1.13	1 1/16"-24	4
5 [5.6]	5.50	BRC-46	1.13	6.21	11.88	17.38	2.25	1.69	1.19	1.69	1 1/4"-11 1/2" NPT	1.25	1 3/16"-16	10
10 [11.6]	5.95	BRC-106	2.32	13.80	11.38	17.33	3.35	2.13	1.25	1.57	-	1.02	M30x2	21

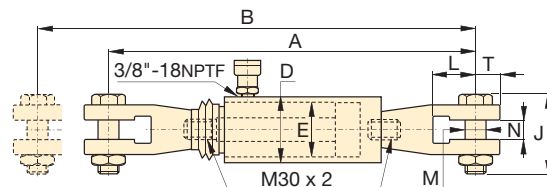

BRP-106C

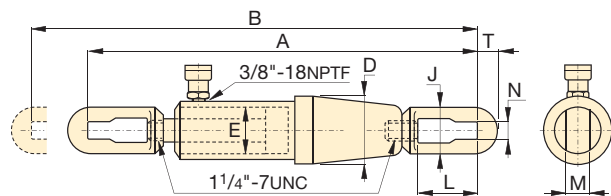

BRP-306

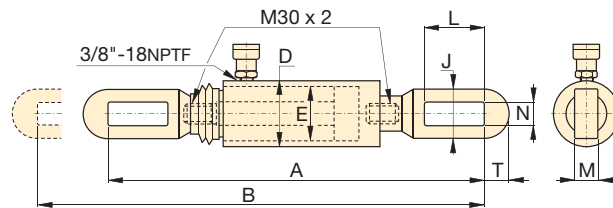

BRP-106L

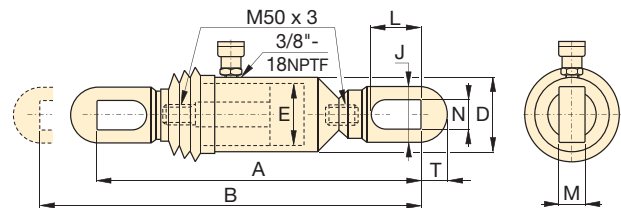

BRP-606

Cylinder Capacity (tons) [maximum]	Stroke (in)	Model Number	Cyl. Effect. Area (in ²)	Oil Capacity (in ³)	Collap. Height A (in)	Ext. Height B (in)	Outside Diam. D (in)	Cyl. Bore Diam. E (in)	Link Height J (in)	Link Opening L (in)	Link Thickness M (in)	Link Width N (in)	Slot to Link End T (in)	Weight (lbs)
10 [11.6]	6.00	BRP-106C*	2.32	13.80	23.11	29.06	3.35	2.13	4.72	2.44	1.19	1.38	1.26	35
	6.00	BRP-106L*	2.32	13.80	22.24	28.19	3.35	2.13	2.64	4.53	0.88	1.19	1.26	24
30 [36.1]	6.00	BRP-306*	7.22	43.27	42.72	48.82	5.39	3.50	4.49	5.71	1.38	1.57	1.97	106
60 [58.8]	6.00	BRP-606*	11.78	70.43	28.34	34.32	5.51	4.33	5.13	5.90	1.57	1.97	2.76	118

Note: BRP-106C, BRP-106L and BRP-606 are fitted with rubber bellows for rod protection.

*Available as a set. See note on previous page. Please refer to drawings above for BRP-106C and BRP-106L.

▼ Shown from left to right: RCH-306, RCH-120, RCH-1003



- Hollow plunger design allows for both pull and push forces
- Single-acting spring return
- Nickel-plated, floating center tube on models over 20 tons increases product life
- Baked enamel finish for increased corrosion resistance
- Collar threads for easy fixturing
- RCH-120 includes AR-630 coupler and has 1/4 NPTF port
- RCH-121 and RCH-1211 have FZ-1630 reducer and AR-630 coupler, all other models feature CR-400 coupler

▼ Hollow plunger cylinder RCH-1003 used in an application for intermediate boom suspension on a dragline.



Versatility in Testing, Maintenance and Tensioning Applications

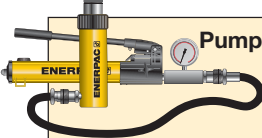

Pump and Cylinder Sets
All cylinders marked with an * are available as sets (cylinder, gauge, couplers, hose and pump) for your ordering convenience. **Page: 54**



Lightweight Aluminum Hollow Plunger Cylinders
If you need a higher cylinder capacity-to-weight ratio the lightweight RACH-Series Aluminum Hollow Plunger Cylinders are the perfect choice. **Page: 16**



Saddles
Most RCH-Series cylinders are equipped with smooth saddles. See table at next page for optional threaded saddles and all dimensional information. **Page: 27**

Cylinder Capacity	Stroke	Model Number	Cyl. Effect. Area	Oil Cap.
(tons) [maximum]	(in)		(in ²)	(in ³)
12 [13.8]	0.31	RCH-120	2.76	0.86
	1.63	RCH-121*	2.76	4.49
	1.63	RCH-1211	2.76	4.49
	3.00	RCH-123	2.76	8.29
20 [23.6]	2.00	RCH-202*	4.73	9.46
	6.10	RCH-206	4.73	28.67
30 [36.1]	2.50	RCH-302*	7.22	18.05
	6.13	RCH-306	7.22	44.23
60 [63.6]	3.00	RCH-603*	12.73	38.20
	6.00	RCH-606	12.73	76.41
100 [103.1]	3.00	RCH-1003*	20.63	61.88

* Available as a set. See note on this page.

Single-Acting, Hollow Plunger Cylinders



Hoses

Enerpac offers a complete line of high quality hydraulic hoses. To ensure the integrity of your system, specify only Enerpac hydraulic hoses.

Page: 114

RCH Series



Capacity:

12-100 tons

Stroke:

.31-6.13 inches

Center Hole Diameter:

.77-3.11 inches

Maximum Operating Pressure:

10,000 psi

Optional Heat Treated Hollow Saddles

Saddle Type	Cylinder Model No.	Saddle Model No.	Saddle Dimensions (in)		
			A	B	C
Threaded Hollow	RCH-202, 206	HP-2015	2.11	1"-8	.38
	RCH-302, 306	HP-3015	2.49	1 1/4"-7	.38
	RCH-603, 606	HP-5016	3.61	1 3/8"-5 1/2"	.50
	RCH-1003	HP-10016	4.97	2 1/2"-8	.51

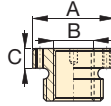

Smooth hollow saddles are standard on all RCH-models (12-ton models are not equipped with saddles).

RCH-121 and RCH-1211 have a 1.88" diameter boss that protrudes 0.25" from base.

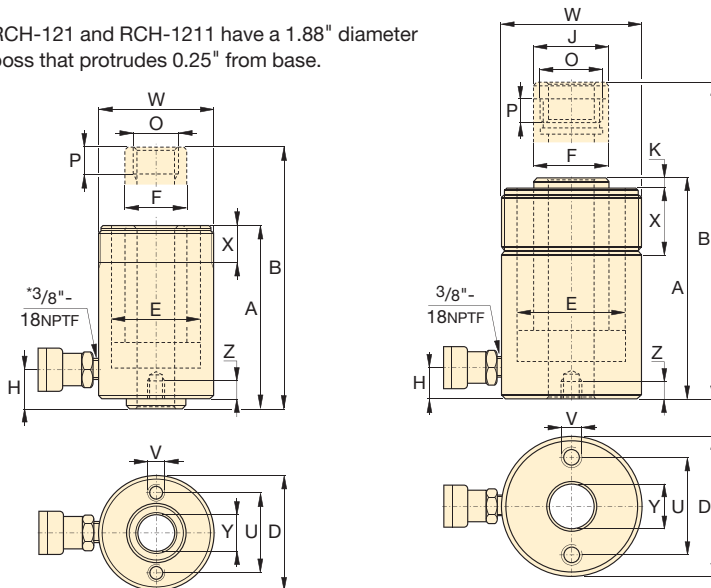

RCH-120 to RCH-123 models

RCH-202 to RCH-1003 models

* 1/4" NPT for RCH-120 only

Base Mounting Hole Dimensions (in)

Model Number	Bolt Circle			Thread Depth Z
	U	V		
RCH-120	2.00	5/16"-18 UNC	.35	
RCH-121	-	-	-	
RCH-1211	-	-	-	
RCH-123	2.00	5/16"-18 UNC	.50	
RCH-202	3.25	3/8"-16 UNC	.37	
RCH-206	3.25	3/8"-16 UNC	.37	
RCH-302	3.63	3/8"-16 UNC	.55	
RCH-306	3.63	3/8"-16 UNC	.55	
RCH-603	5.13	1/2"-13 UNC	.55	
RCH-606	5.13	1/2"-13 UNC	.55	
RCH-1003	7.00	5/8"-11 UNC	.75	

Collap. Height	Ext. Height	Outside Diam.	Cyl. Bore Diam.	Plngr. Diam.	Cyl. Base to Advance Port	Saddle Diameter	Saddle Protrusion from Plngr.	Plunger Internal Thread	Plunger Thread Length	Collar Thread	Collar Thread Length	Center Hole Diam.	Weight (lbs)	Model Number
A (in)	B (in)	D (in)	E (in)	F (in)	H (in)	J (in)	K (in)	O (in)	P (in)	W (in)	X (in)	Y (in)		
2.19	2.50	2.75	2.13	1.38	.38	-	-	3/4"-16 UN	.63	2 3/4"-16	1.19	.77	3.2	RCH-120
4.75	6.38	2.75	2.13	1.38	.98	-	-	-	-	2 3/4"-16	1.19	.77	6.2	RCH-121*
4.75	6.38	2.75	2.13	1.38	.98	-	-	3/4"-16 UN	.63	2 3/4"-16	1.19	.77	6.2	RCH-1211
7.25	10.25	2.75	2.13	1.38	.98	-	-	-	-	2 3/4"-16	1.19	.77	9.8	RCH-123
6.38	8.38	3.88	2.88	2.13	.75	2.13	.27	1 9/16"-16 UN	.75	3 7/8"-12	1.50	1.06	17	RCH-202*
12.05	18.11	3.88	2.88	2.13	.75	2.13	.27	1 9/16"-16 UN	.75	3 7/8"-12	1.50	1.06	31	RCH-206
7.03	9.53	4.50	3.50	2.50	.85	2.50	.38	1 13/16"-16 UN	.88	4 1/2"-12	1.66	1.31	24	RCH-302*
13.00	19.13	4.50	3.50	2.50	1.00	2.50	.38	1 13/16"-16 UN	.88	4 1/2"-12	1.66	1.31	48	RCH-306
9.75	12.75	6.25	4.88	3.63	1.25	3.61	.50	2 3/4"-16 UN	.75	6 1/4"-12	1.91	2.12	62	RCH-603*
12.75	18.75	6.25	4.88	3.63	1.25	3.61	.50	2 3/4"-16 UN	.75	6 1/4"-12	1.91	2.12	78	RCH-606
10.00	13.00	8.38	6.50	5.00	1.50	4.97	.50	4"-16 UN	1.00	8 3/8"-12	2.38	3.11	132	RCH-1003*

▼ Shown from left to right: RRH-3010, RRH-1001, RRH-6010



Versatility in Testing, Maintenance and Tensioning Applications



Pump Selection

A double-acting cylinder must be powered by a pump with a 4-way valve.

Page: 57



Gauges

Minimize the risk of overloading and ensure long, dependable service from your equipment. Refer to the System Components section for a full range of gauges.

Page: 113



Saddles

All RRH-Series cylinders are equipped with smooth saddles. See table on next page for optional threaded saddles and all dimensional information.

Page: 29

- Relief valves prevent damage in case of over-pressurization
- Baked enamel finish for increased corrosion resistance
- Collar threads enable easy fixturing (except RRH-1001 and RRH-1508)
- Double-acting operation for fast retraction
- Nickel-plated, floating center tube increases product life
- Hollow plunger allows for both pull and push forces
- CR-400 couplers and dust caps included on all models
- Plunger wiper reduces contamination, extending cylinder life

▼ Double-acting hollow plunger cylinders are applied for bridge launching systems.



Cylinder Capacity (ton)	Stroke (in)	Model Number	Max. Cylinder Capacity (ton)		Cylinder Effective Area (in ²)		Oil Capacity (in ³)	
			Advance	Retract	Advance	Retract	Advance	Retract
30	7.00	RRH-307	36	24	7.22	4.71	50.55	32.99
	10.13	RRH-3010	36	24	7.22	4.71	73.12	47.71
60	3.50	RRH-603	64	42	12.73	8.37	44.57	29.21
	6.50	RRH-606	64	42	12.73	8.37	82.77	54.24
	10.12	RRH-6010	64	42	12.73	8.37	128.94	84.49
100	1.50	RRH-1001	103	68	20.63	13.54	30.94	20.32
	3.00	RRH-1003	103	68	20.63	13.54	61.88	40.64
	6.00	RRH-1006	103	68	20.63	13.54	123.76	81.29
	10.13	RRH-10010	103	68	20.63	13.54	208.84	137.17
150	8.00	RRH-1508	158	80	31.62	15.91	252.97	127.23

Double-Acting, Hollow Plunger Cylinders



Hoses

Enerpac offers a complete line of high quality hydraulic hoses. To ensure the integrity of your system, specify only Enerpac hydraulic hoses.

Page: 114

RRH Series



Capacity:

30-150 tons

Stroke:

1.50-10.13 inches

Center Hole Diameter:

1.31-3.13 inches

Maximum Operating Pressure:

10,000 psi

Optional Heat Treated Saddles

Saddle Type	Cylinder Model Number	Saddle Model No.	Saddle Dimensions (in)		
			A	B	C
Threaded Hollow	RRH-307, 3010	HP-3015	2.49	1¼"-7	.38
	RRH-603, 606, 6010	HP-5016	3.61	1½"-5½	.50
	RRH-1001, 1003, RRH-1006, 10010	HP-10016	4.97	2½"-8	.51

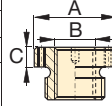

Smooth hollow saddles are standard on all RRH-models.

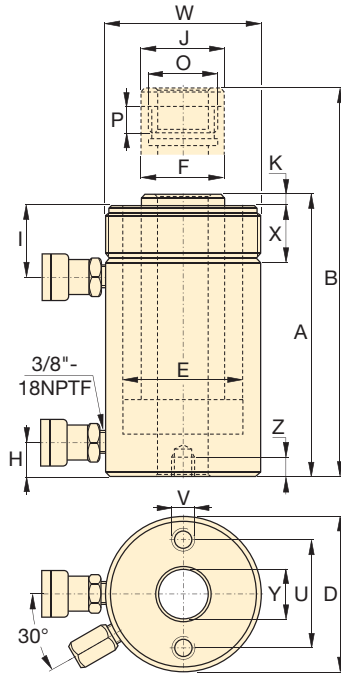

Base Mounting Hole Dimensions (in)

Model Number	Bolt Circle U	Thread V	Thread Depth Z
RRH-307	3.63	¾" - 16	.62
RRH-3010	3.63	¾" - 16	.62
RRH-603	5.12	½" - 13	.55
RRH-606	5.12	½" - 13	.55
RRH-6010	5.12	½" - 13	.55
RRH-1001	7.00	⅝" - 11	.75
RRH-1003	7.00	⅝" - 11	.75
RRH-1006	7.00	⅝" - 11	.75
RRH-10010	7.00	⅝" - 11	.75
RRH-1508	-	-	-

Collap. Height	Ext. Height	Out. Diam.	Cyl. Bore Diam.	Plngr. Diam.	Cyl. Base to Adv. Port	Cyl. Top to Return Port	Saddle Diam.	Saddle Protrusion from Plngr.	Thread	Plunger Thread Length	Collar Thread	Collar Thread Length	Center Hole Diam.	Wt.	Model Number
A	B	D	E	F	H	I	J	K	O	P	W	X	Y	(lbs)	
(in)	(in)	(in)	(in)	(in)	(in)	(in)	(in)	(in)	(in)	(in)	(in)	(in)	(in)		
13.00	20.00	4.50	3.50	2.50	1.00	2.38	2.50	.38	1 ¹³ / ₁₆ "-16	.88	4½"-12	1.66	1.31	48	RRH-307
17.00	27.13	4.50	3.50	2.50	1.00	2.38	2.50	.38	1 ¹³ / ₁₆ "-16	.88	4½"-12	1.66	1.31	60	RRH-3010
9.75	13.25	6.25	4.88	3.63	1.25	2.63	3.61	.50	2¾"-16	.75	6¼"-12	1.91	2.13	62	RRH-603
12.75	19.25	6.25	4.88	3.63	1.25	2.63	3.61	.50	2¾"-16	.75	6¼"-12	1.91	2.13	78	RRH-606
17.25	27.38	6.25	4.88	3.63	1.25	2.63	3.61	.50	2¾"-16	.75	6¼"-12	1.91	2.13	101	RRH-6010
6.50	8.00	8.38	6.50	5.00	1.50	1.75	4.97	.50	4"-16	1.00	-	-	3.13	85	RRH-1001
10.00	13.00	8.38	6.50	5.00	1.50	3.38	4.97	.50	4"-16	1.00	8¾"-12	2.38	3.13	135	RRH-1003
13.50	19.50	8.38	6.50	5.00	1.50	3.38	4.97	.50	4"-16	1.00	8¾"-12	2.38	3.13	175	RRH-1006
18.13	28.25	8.38	6.50	5.00	1.50	3.38	4.97	.50	4"-16	1.00	8¾"-12	2.38	3.13	235	RRH-10010
13.75	21.75	9.75	7.50	6.00	1.50	2.38	5.00	.19	4¼"-12	1.00	-	-	3.13	245	RRH-1508

▼ Shown from left to right: RD-2510, RD-96, RD-256, RD-41, RD-166



High Precision and High Cycle Performance



Speed Chart

See the Enerpac Cylinder Speed Chart in our 'Yellow Pages' to determine your approximate cylinder speed.

Page: 251

- Designed for long life, the best choice for production applications
- Unique mounting configurations simplify fixturing
- Baked enamel finish for increased corrosion resistance
- Double-acting operation develops force in both directions, providing maximum versatility
- Plunger wiper reduces contamination, extending cylinder life

▼ Clamping application using Enerpac RD cylinders (with clevis eye attachments on both ends) for their high-pressure capability and mounting flexibility.



Cylinder Capacity (tons)	Stroke (in)	Model Number	Max. Cylinder Capacity (tons)		Cylinder Effective Area (in ²)		Oil Capacity (in ³)		Collap. Height A (in)	Ext. Height B (in)	Body Length C (in)	Outside Diam. D (in)	Cylinder Bore Diam. E (in)	Plunger Diam. F (in)
			Advance	Retract	Advance	Retract	Advance	Retract						
4	1.13	RD-41	4	2	.79	.34	.88	.39	7.31	8.44	6.38	2.00	1.00	.75
	3.13	RD-43	4	2	.79	.34	2.45	1.07	9.31	12.44	8.38	2.00	1.00	.75
	6.13	RD-46	4	2	.79	.34	4.81	2.10	12.31	18.44	11.38	2.00	1.00	.75
9	1.13	RD-91	9	5	1.77	.98	1.99	1.10	8.75	9.88	7.80	2.50	1.50	1.00
	3.13	RD-93	9	5	1.77	.98	5.52	3.07	10.78	13.91	9.80	2.50	1.50	1.00
	6.13	RD-96	9	5	1.77	.98	10.82	6.01	13.78	19.91	12.80	2.50	1.50	1.00
	10.13	RD-910	9	5	1.77	.98	17.89	9.94	17.78	27.91	16.81	2.50	1.50	1.00
16	6.25	RD-166	16	8	3.14	1.66	19.63	10.35	15.31	21.56	14.13	3.00	2.00	1.38
	10.25	RD-1610	16	8	3.14	1.66	32.20	16.98	19.31	29.56	18.11	3.00	2.00	1.38
25	6.25	RD-256	25	11	4.91	2.15	30.68	13.42	16.69	22.94	15.63	3.63	2.50	1.88
	10.25	RD-2510	25	11	4.91	2.15	50.31	22.01	20.69	30.94	19.61	3.63	2.50	1.88

Double-Acting, Precision Production Cylinders

▼ RD CYLINDER ATTACHMENTS

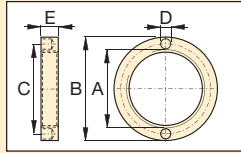

Retainer Nut
For locking foot or flange mountings. Tightens onto cylinder collar threads (included with foot and flange mounting kits)

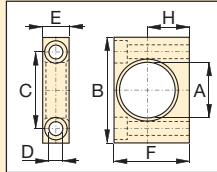

Foot Mounting
Mounts onto cylinder collar. Mounting screws not included.

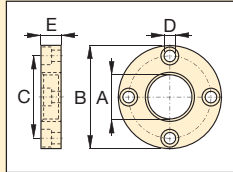

Flange Mounting
Mounts onto cylinder collar. Mounting screws not included.

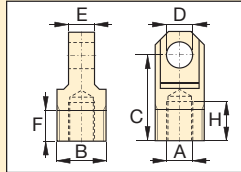

Clevis Eye
Threads onto plunger or into cylinder base

Model Number	RD-Cyl: (tons)	Dimensions (in)						
		A	B	C	D	E	F	H
Foot Mounting with Retainer Nut								
AD-141	4	1.38	3.00	2.00	.41	.75	2.25	1.25
AD-171	9	2.00	4.00	2.88	.53	1.00	3.25	1.75
AD-181	16	2.63	5.00	3.75	.78	1.38	4.00	2.06
AD-191	25	3.25	6.25	4.62	1.03	1.75	4.88	2.50
Flange Mounting with Retainer Nut								
AD-142	4	1.38	3.88	3.09	.41	.75	-	-
AD-172	9	2.00	4.75	3.88	.41	1.00	-	-
AD-182	16	2.63	5.63	4.56	.53	1.38	-	-
AD-192	25	3.25	6.50	5.34	.66	1.75	-	-
Retainer Nut								
AD-143	4	1.375-12 UNF	2.25	1.81	.25	.38	-	-
AD-173	9	2.000-12 UN	3.00	2.50	.27	.50	-	-
AD-183	16	2.625-16 UN	3.63	3.12	.27	.75	-	-
AD-193	25	3.250-16 UN	4.25	3.75	.27	1.00	-	-
Clevis Eye								
AD-150	4	.500-20 UNF	1.125-20 UN	2.06	.63	.62	.75	.94
AD-151	9	.750-16 UNF	1.688-18 UNEF	2.25	.75	1.00	1.00	.94
AD-152	16	1.125-12 UNF	2.188-16 UNS	3.06	1.00	1.25	1.00	1.19
AD-153	25	1.500-12 UNF	2.750-16	3.06	1.25	1.50	1.00	1.06

RD Series



Capacity:
4-25 tons

Stroke:
1.13-10.25 inches

Maximum Operating Pressure:
10,000 psi

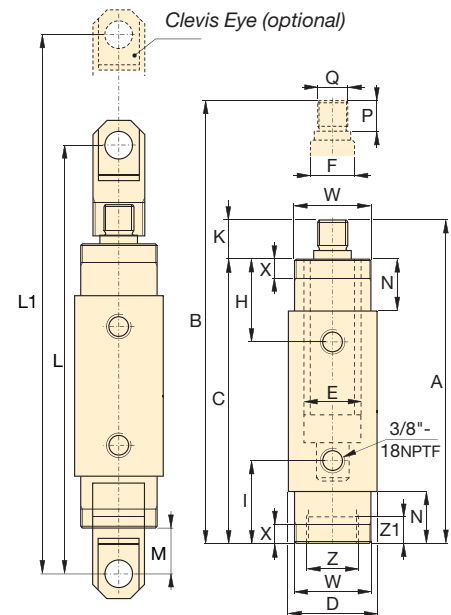

Top to Ret. Port H (in)	Bottom to Adv. Port I (in)	Plunger Protrusion K (in)	Clevis Eye Mounting Dimensions			Neck Length N (in)	Plunger Thread Length P (in)	Plunger External Thread Q (in)	Cylinder Mounting Dimensions (in)				Wt. (lbs)	Model Number
			L (in)	L1 (in)	M (in)				Collar Thread W	Collar Thread Length X	Int. Base Thread Z	Int. Base Thread Length Z1		
1.88	1.88	.94	10.12	11.25	1.61	1.13	.75	1/2"-20	1 3/8"-12	.44	1 1/8"-20	.35	4.8	RD-41
1.88	1.88	.94	12.12	15.25	1.61	1.13	.75	1/2"-20	1 3/8"-12	.44	1 1/8"-20	.35	6.4	RD-43
1.88	1.88	.94	15.12	21.25	1.61	1.13	.75	1/2"-20	1 3/8"-12	.44	1 1/8"-20	.35	9.0	RD-46
2.27	2.27	.98	11.61	12.76	1.50	1.50	.75	3/4"-16	2"-12	.56	1 11/16"-18	.55	9.0	RD-91
2.27	2.27	.98	13.66	16.79	1.50	1.50	.75	3/4"-16	2"-12	.56	1 11/16"-18	.55	11.0	RD-93
2.27	2.27	.98	16.66	22.79	1.50	1.50	.75	3/4"-16	2"-12	.56	1 11/16"-18	.55	14.0	RD-96
2.27	2.27	.98	20.66	30.79	1.50	1.50	.75	3/4"-16	2"-12	.56	1 11/16"-18	.55	19.0	RD-910
2.90	2.90	1.19	19.32	25.57	2.05	2.13	1.00	1 1/8"-12	2 5/8"-16	.88	2 3/16"-16	.94	22.0	RD-166
2.90	2.90	1.19	23.32	33.57	2.05	2.13	1.00	1 1/8"-12	2 5/8"-16	.88	2 3/16"-16	.94	29.0	RD-1610
3.50	3.50	1.06	20.86	27.11	2.09	2.75	1.00	1 1/2"-12	3 1/4"-16	1.13	2 3/4"-16	1.02	36.0	RD-256
3.50	3.50	1.08	24.86	35.11	2.09	2.75	1.00	1 1/2"-12	3 1/4"-16	1.13	2 3/4"-16	1.02	46.0	RD-2510

▼ Shown from left to right: RR-10013, RR-1502, RR-20013, RR-1010, RR-7513



- Collar threads, plunger threads and base mounting holes for easy fixturing (on most models)
- Baked enamel finish for increased corrosion resistance
- Removable hardened saddles protect plunger during lifting and pressing
- Built-in safety valve prevents accidental over-pressurization
- CR-400 couplers included on all models
- Plunger wiper reduces contamination, extending cylinder life

▼ These long stroke RR-cylinders are attached to a sliding and guiding system pulling the arched roof assembly of Athen's Olympic Stadium step by step into the final position.



Most Versatile Performers

Rugged enough for the toughest job site uses and precision designed for high-cycle industrial uses.



Pump Selection

A double-acting cylinder must be powered by a pump with a 4-way valve.

Page: 57



Saddles

RR-Series cylinders up to 75-ton have plunger thread for installation of CAT-Series tilt saddles.

Page: 33



Optimum Performance

Enerpac's range of Z-Class electric pumps, fitted with manual or solenoid operated 4-way valves, offer optimum combinations with RR cylinders.

Page: 76

▼ RR-cylinders provide power and precision in a special hydraulic press.



Double-Acting Long Stroke Cylinders

▼ QUICK SELECTION CHART

For complete technical information see next page.

Cylinder Capacity (tons)	Stroke (in)	Model Number	Cylinder Effective Area (in ²)		Oil Capacity (in ³)		Collap. Height (in)
			Push	Pull	Push	Pull	
			10	10.00	RR-1010*	2.23	
	12.00	RR-1012*	2.23	.80	26.80	9.00	18.00
30	8.25	RR-308*	6.51	3.00	53.67	25.00	15.25
	14.50	RR-3014*	6.51	3.00	92.70	43.00	21.63
50	6.13	RR-506	11.06	3.40	67.77	21.00	13.06
	13.13	RR-5013	11.06	3.40	145.17	44.00	20.06
	20.13	RR-5020	11.06	3.40	222.56	68.00	28.88
75	6.13	RR-756	15.92	4.90	97.58	29.00	13.69
	13.13	RR-7513	15.92	4.90	209.00	64.00	20.69
100	6.63	RR-1006	20.65	9.60	136.93	63.00	14.06
	13.13	RR-10013	20.65	9.60	271.17	126.00	20.63
	18.13	RR-10018	20.65	9.60	374.44	174.00	27.06
150	2.25	RR-1502	30.71	14.80	69.11	33.00	7.72
	6.13	RR-1506	30.71	14.80	188.28	91.00	15.19
	13.13	RR-15013	30.71	14.80	403.27	194.00	22.20
	32.13	RR-15032	30.71	14.80	986.84	475.00	43.94
200	6.00	RR-2006	44.21	22.50	265.28	135.00	16.94
	13.00	RR-20013	44.21	22.50	574.78	293.00	23.94
	18.00	RR-20018	44.21	22.50	795.85	396.00	30.13
	24.00	RR-20024	44.21	22.50	1,061	528.00	36.13
	36.00	RR-20036	44.21	22.50	1,592	792.00	48.13
300	48.00	RR-20048	44.21	22.50	2,122	1,056	60.13
	6.00	RR-3006	70.93	38.00	425.56	228.00	19.13
	12.00	RR-30012	70.93	38.00	851.12	456.00	25.13
	18.00	RR-30018	70.93	38.00	1,277	684.00	31.13
	24.00	RR-30024	70.93	38.00	1,702	912.00	37.13
400	36.00	RR-30036	70.93	38.00	2,553	1,368	49.13
	48.00	RR-30048	70.93	38.00	3,405	1,824	61.13
	6.00	RR-4006	95.09	51.00	570.51	306.00	21.19
	12.00	RR-40012	95.09	51.00	1,141	612.00	27.19
	18.00	RR-40018	95.09	51.00	1,712	918.00	33.19
	24.00	RR-40024	95.09	51.00	2,282	1,224	39.19
500	36.00	RR-40036	95.09	51.00	3,423	1,836	51.19
	48.00	RR-40048	95.09	51.00	4,564	2,448	63.19
	6.00	RR-5006	113.15	63.00	678	378.00	22.75
	12.00	RR-50012	113.15	63.00	1,358	756.00	28.75
	18.00	RR-50018	113.15	63.00	2,037	1,134	34.75
500	24.00	RR-50024	113.15	63.00	2,716	1,512	40.75
	36.00	RR-50036	113.15	63.00	4,074	2,264	52.75
	48.00	RR-50048	113.15	63.00	5,431	3,024	64.75

RR Series



Capacity:
10-500 tons

Stroke:
2.25-48.00 inches

Maximum Operating Pressure:
10,000 psi



Energac CLRG-Series

If you do not have a high cycle application, Energac **CLRG-Series** cylinders may be the right alternative.

Page: 40



Speed Chart

See the Energac Cylinder Speed Chart in our "Yellow Pages" to determine your approximate cylinder speed.

Page: 251



Optional Snap-in Saddles

Optional snap-in saddles for RR-Series double-acting cylinders:

Saddle Type	Cylinder Model Number	Saddle Model Number
Flat	RR-1010, 1012	A-102F
	RR-1010, 1012	CAT-10
Tilt	RR-308, 3014	CAT-50
	RR-506, 5013	CAT-100
	RR-5020, 756	
	RR-7513	

Standard Saddles

Grooved	RR-1010, 1012	A-102G
	RR-308, 3014	A-252G

For additional information on saddles:

Page: 10

RR-Series, Double-Acting Cylinders

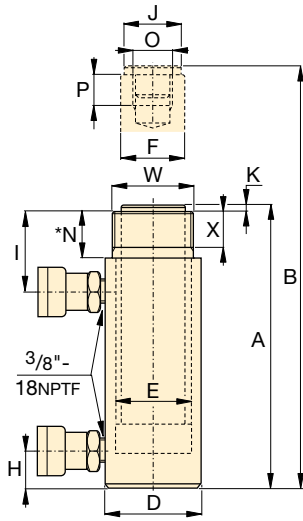

RR-1010 to RR-3014 models

* For RR-1010 and RR-1012:
N = 1.26 inch; for RR-308 and
RR-3014: N = 2.20 inch.

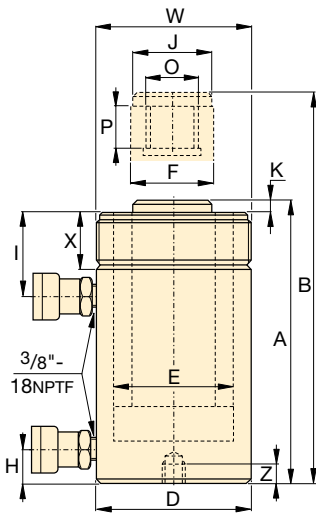

RR-506 to RR-50048 models

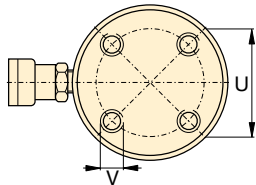

RR-1006 to RR-30048

No mounting holes:
RR-506, 5013
RR-756, 7513
RR-1502, 15032



Cylinder retract capacity for certain RR cylinders may be less than theoretical values, as a result of reduced relief valve pressure settings:

RR-308/3014: 4000 psi
RR-506/5013/5020: 6950 psi
RR-756/7513: 7200 psi

◀ For full features see page 32.

Cylinder Capacity (ton)	Stroke (in)	Model Number	Max. Cylinder Capacity (tons)		Cylinder Effective Area (in ²)		Oil Capacity (in ³)		Collap. Height A (in)	Ext. Height B (in)	Outside Diam. D (in)
			Push	Pull	Push	Pull	Push	Pull			
10	10.00	RR-1010*	11.1	4.0	2.23	.80	22.33	8.00	16.13	26.13	2.88
	12.00	RR-1012*	11.1	4.0	2.23	.80	26.80	9.00	18.00	30.00	2.88
30	8.25	RR-308*	32.5	6.0	6.51	3.00	53.67	25.00	15.25	23.50	4.00
	14.50	RR-3014*	32.5	6.0	6.51	3.00	92.70	43.00	21.63	36.13	4.00
50	6.13	RR-506	55.3	11.8	11.06	3.40	67.77	21.00	13.06	19.19	5.00
	13.13	RR-5013	55.3	11.8	11.06	3.40	145.17	44.00	20.06	33.19	5.00
	20.13	RR-5020	55.3	11.8	11.06	3.40	222.56	68.00	28.88	49.00	5.00
75	6.13	RR-756	79.6	17.6	15.92	4.90	97.58	29.00	13.69	19.81	5.75
	13.13	RR-7513	79.6	17.6	15.92	4.90	209.00	64.00	20.69	33.81	5.75
100	6.63	RR-1006	103.2	48.0	20.65	9.60	136.93	63.00	14.06	20.69	7.00
	13.13	RR-10013	103.2	48.0	20.65	9.60	271.17	126.00	20.63	33.75	7.00
	18.13	RR-10018	103.2	48.0	20.65	9.60	374.44	174.00	27.06	45.19	7.00
150	2.25	RR-1502	153.5	74.0	30.71	14.80	69.11	33.00	7.19	9.44	8.00
	6.13	RR-1506	153.5	74.0	30.71	14.80	188.28	91.00	15.19	21.31	8.00
	13.13	RR-15013	153.5	74.0	30.71	14.80	403.27	194.00	22.20	35.31	8.00
	32.13	RR-15032	153.5	74.0	30.71	14.80	986.84	475.00	43.94	76.06	8.00
200	6.00	RR-2006	221.0	112.5	44.21	22.50	265.28	135.00	16.94	22.94	9.75
	13.00	RR-20013	221.0	112.5	44.21	22.50	574.78	293.00	23.94	36.94	9.75
	18.00	RR-20018	221.0	112.5	44.21	22.50	795.85	396.00	30.13	48.13	9.75
	24.00	RR-20024	221.0	112.5	44.21	22.50	1,061	528.00	36.13	60.13	9.75
	36.00	RR-20036	221.0	112.5	44.21	22.50	1,592	792.00	48.13	84.13	9.75
300	48.00	RR-20048	221.0	112.5	44.21	22.50	2,122	1,056	60.13	108.13	9.75
	6.00	RR-3006	354.6	190.0	70.93	38.00	425.56	228.00	19.13	25.13	12.25
	12.00	RR-30012	354.6	190.0	70.93	38.00	851.12	456.00	25.13	37.13	12.25
	18.00	RR-30018	354.6	190.0	70.93	38.00	1,277	684.00	31.13	49.13	12.25
	24.00	RR-30024	354.6	190.0	70.93	38.00	1,702	912.00	37.13	61.13	12.25
400	36.00	RR-30036	354.6	190.0	70.93	38.00	2,553	1368	49.13	85.13	12.25
	48.00	RR-30048	354.6	190.0	70.93	38.00	3,405	1824	61.13	109.13	12.25
	6.00	RR-4006	475.4	255.0	95.09	51.00	570.51	306.00	21.19	27.19	14.13
	12.00	RR-40012	475.4	255.0	95.09	51.00	1,141	612.00	27.19	39.19	14.13
	18.00	RR-40018	475.4	255.0	95.09	51.00	1,712	918.00	33.19	51.19	14.13
500	24.00	RR-40024	475.4	255.0	95.09	51.00	2,282	1224	39.19	63.19	14.13
	36.00	RR-40036	475.4	255.0	95.09	51.00	3,423	1836	51.19	87.19	14.13
	48.00	RR-40048	475.4	255.0	95.09	51.00	4,564	2448	63.19	111.19	14.13
	6.00	RR-5006	565.7	315.0	113.15	63.00	678.92	378.00	22.75	28.75	15.63
	12.00	RR-50012	565.7	315.0	113.15	63.00	1,358	756.00	28.75	40.75	15.63
500	18.00	RR-50018	565.7	315.0	113.15	63.00	2,037	1134	34.75	52.75	15.63
	24.00	RR-50024	565.7	315.0	113.15	63.00	2,716	1512	40.75	64.75	15.63
	36.00	RR-50036	565.7	315.0	113.15	63.00	4,074	2268	52.75	88.75	15.63
48.00	RR-50048	565.7	315.0	113.15	63.00	5,431	3024	64.75	112.75	15.63	

* For RR-1010 and RR-1012: N = 1.26 inch; for RR-308 and RR-3014: N = 2.20 inch.

Double-Acting Long Stroke Cylinders

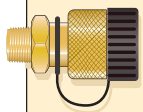

Couplers Included!
CR-400 couplers included on all models. Fits all HC-Series hoses.

Capacity:
10-500 tons

Stroke:
2.25-48.00 inches

Maximum Operating Pressure:
10,000 psi

RR Series



Cylinder Bore Diameter	Plunger Diameter	Base to Adv. Port	Top to Return Port	Saddle Diameter	Saddle Protrusion from Plngr.	Plunger Internal Thread	Plunger Thread Length	Base Mounting Holes			Collar Thread	Collar Thread Length	Weight (lbs)	Model Number
								Bolt Cir. Diam. U (in)	Thread V (in)	Thread Depth Z (in)				
E (in)	F (in)	H (in)	I (in)	J (in)	K (in)	O (in)	P (in)	U (in)	V (in)	Z (in)	W (in)	X (in)		
1.69	1.38	1.44	2.25	1.38	.24	1-8	1.00	-	-	-	2 1/4-14	1.06	28	RR-1010*
1.69	1.38	1.44	2.25	1.38	.24	1-8	1.00	-	-	-	2 1/4-14	1.06	31	RR-1012*
2.88	2.13	1.44	3.19	2.00	.41	1 1/2-16	1.00	-	-	-	3 5/16-12	1.94	40	RR-308*
2.88	2.13	1.56	3.19	2.00	.41	1 1/2-16	1.00	-	-	-	3 5/16-12	1.94	64	RR-3014*
3.75	3.13	1.13	3.00	2.81	.11	1-12	1.00	-	-	-	5-12	2.00	67	RR-506
3.75	3.13	1.13	3.00	2.81	.11	1-12	1.00	-	-	-	5-12	2.00	115	RR-5013
3.75	3.13	2.25	3.00	2.81	.11	1-12	1.00	3.00	-	-	5-12	2.00	150	RR-5020
4.50	3.75	1.19	3.00	2.81	.25	1-12	1.50	-	-	-	5 3/4-12	1.50	92	RR-756
4.50	3.75	1.19	3.19	2.81	.25	1-12	1.50	-	-	-	5 3/4-12	1.50	150	RR-7513
5.13	3.75	1.50	2.81	3.00	.13	1 3/4-12	1.38	5.50	3/4-10	1.00	6 7/8-12	2.00	135	RR-1006
5.13	3.75	1.50	2.81	3.00	.13	1 3/4-12	1.38	5.50	3/4-10	1.00	6 7/8-12	2.00	205	RR-10013
5.13	3.75	1.63	3.63	3.00	.13	1 3/4-12	1.38	5.50	3/4-10	1.00	6 7/8-12	2.00	260	RR-10018
6.25	4.50	.88	2.63	3.67	.06	-	-	-	-	-	-	-	110	RR-1502
6.25	4.50	1.94	3.31	4.49	.75	3 3/8-16	1.38	6.25	3/4-16	1.00	8-12	2.36	205	RR-1506
6.25	4.50	1.94	3.31	4.49	.75	3 3/8-16	1.38	6.25	3/4-16	1.00	8-12	2.36	275	RR-15013
6.25	4.50	3.31	3.31	4.49	.75	3 3/8-16	1.38	-	-	-	8-12	2.36	525	RR-15032
7.50	5.25	2.25	3.81	5.25	.88	-	-	5.00	1-8	1.00	-	-	325	RR-2006
7.50	5.25	2.25	3.81	5.25	.88	2 1/2-12	2.50	5.00	1-8	1.00	9 3/4-12	2.13	440	RR-20013
7.50	5.25	3.38	4.00	5.25	.88	2 1/2-12	2.50	5.00	1-8	1.00	9 3/4-12	2.13	450	RR-20018
7.50	5.25	3.38	4.00	5.25	.88	2 1/2-12	2.50	5.00	1-8	1.00	9 3/4-12	2.13	616	RR-20024
7.50	5.25	3.38	4.00	5.25	.88	2 1/2-12	2.50	5.00	1-8	1.00	9 3/4-12	2.13	845	RR-20036
7.50	5.25	3.38	4.00	5.25	.88	2 1/2-12	2.50	5.00	1-8	1.00	9 3/4-12	2.13	1065	RR-20048
9.50	6.50	3.50	4.50	6.50	1.13	2 1/2-12	3.25	6.25	1 1/4-7	1.75	12 1/4-12	2.31	441	RR-3006
9.50	6.50	3.50	4.50	6.50	1.13	2 1/2-12	3.25	6.25	1 1/4-7	1.75	12 1/4-12	2.31	608	RR-30012
9.50	6.50	3.50	4.50	6.50	1.13	2 1/2-12	3.25	6.25	1 1/4-7	1.75	12 1/4-12	2.31	776	RR-30018
9.50	6.50	3.50	4.50	6.50	1.13	2 1/2-12	3.25	6.25	1 1/4-7	1.75	12 1/4-12	2.31	1034	RR-30024
9.50	6.50	3.50	4.50	6.50	1.13	2 1/2-12	3.25	6.25	1 1/4-7	1.75	12 1/4-12	2.31	1385	RR-30036
9.50	6.50	3.50	4.50	6.50	1.13	2 1/2-12	3.25	6.25	1 1/4-7	1.75	12 1/4-12	2.31	1720	RR-30048
11.00	7.50	4.25	5.25	7.50	1.13	3-12	3.75	8.00	1 1/2-6	2.00	14 1/8-8	2.56	670	RR-4006
11.00	7.50	4.25	5.25	7.50	1.13	3-12	3.75	8.00	1 1/2-6	2.00	14 1/8-8	2.56	880	RR-40012
11.00	7.50	4.25	5.25	7.50	1.13	3-12	3.75	8.00	1 1/2-6	2.00	14 1/8-8	2.56	1000	RR-40018
11.00	7.50	4.25	5.25	7.50	1.13	3-12	3.75	8.00	1 1/2-6	2.00	14 1/8-8	2.56	1317	RR-40024
11.00	7.50	4.25	5.25	7.50	1.13	3-12	3.75	8.00	1 1/2-6	2.00	14 1/8-8	2.56	1746	RR-40036
11.00	7.50	4.25	5.25	7.50	1.13	3-12	3.75	8.00	1 1/2-6	2.00	14 1/8-8	2.56	2162	RR-40048
12.00	8.00	4.75	6.00	8.00	1.13	3 1/4-12	4.25	8.00	1 3/4-5	2.12	15 5/8-8	3.13	953	RR-5006
12.00	8.00	4.75	6.00	8.00	1.13	3 1/4-12	4.25	8.00	1 3/4-5	2.12	15 5/8-8	3.13	1300	RR-50012
12.00	8.00	4.75	6.00	8.00	1.13	3 1/4-12	4.25	8.00	1 3/4-5	2.12	15 5/8-8	3.13	1500	RR-50018
12.00	8.00	4.75	6.00	8.00	1.13	3 1/4-12	4.25	8.00	1 3/4-5	2.12	15 5/8-8	3.13	1800	RR-50024
12.00	8.00	4.75	6.00	8.00	1.13	3 1/4-12	4.25	8.00	1 3/4-5	2.12	15 5/8-8	3.13	2210	RR-50036
12.00	8.00	4.75	6.00	8.00	1.13	3 1/4-12	4.25	8.00	1 3/4-5	2.12	15 5/8-8	3.13	2700	RR-50048

▼ Shown from left to right: CLSG-1506, CLSG-2006, CLSG-506



- Integral stop ring provides piston blow-out protection
- Baked enamel outside finish and plated pistons provide superior corrosion protection
- Base mounting holes standard on all models
- Plunger wiper reduces contamination, extending cylinder life
- Single-acting load return

▼ Eight CLSG-2506 cylinders equipped with tilting saddles lifted the planking of the bridge as the pier heads were being rebuilt.



The Single-Acting Heavy Lifting Solution with Integral Stop Ring



Saddles

All **CLSG-Series** cylinders are equipped with bolt-on removable grooved saddles.

For information on optional tilt saddles, see selection chart.

Page: 39



Gauges

Minimize the risk of overloading and ensure long, dependable service from your equipment. Refer to

the **System Components** section for a full range of gauges.

Page: 113



Optimum Performance

Enerpac's range of **Z-Class** electric pumps, fitted with manual or solenoid operated 3-way valves, offer optimum combinations with CLSG cylinders.

Page: 76



Low Height - High Tonnage

When low height with high force is required, **CLP-Series** Pancake Cylinders with lock nut offer the solution to lift the first few inches.

Page: 20

Single-Acting, High Tonnage Cylinders

▼ QUICK SELECTION CHART

For complete technical information see next page.

Cylinder Capacity (ton) [maximum]	Stroke (in)	Model Number	Cylinder Effective Area (in ²)	Oil Capacity (in ³)	Collapsed Height (in)	Weight (lbs)
50 [59.1]	1.97	CLSG-502	11.81	23.25	6.38	37
	3.94	CLSG-504	11.81	46.50	8.35	44
	5.91	CLSG-506	11.81	69.75	10.31	51
	7.87	CLSG-508	11.81	93.00	12.28	60
	9.84	CLSG-5010	11.81	116.25	14.25	68
	11.81	CLSG-5012	11.81	139.50	16.22	75
100 [102.9]	1.97	CLSG-1002	20.57	40.50	7.16	42
	3.94	CLSG-1004	20.57	81.00	9.13	64
	5.91	CLSG-1006	20.57	121.50	11.09	88
	7.87	CLSG-1008	20.57	162.00	13.06	110
	9.84	CLSG-10010	20.57	202.50	15.03	134
	11.81	CLSG-10012	20.57	242.99	17.00	157
150 [153.9]	1.97	CLSG-1502	30.78	60.58	7.72	86
	3.94	CLSG-1504	30.78	121.17	9.69	115
	5.91	CLSG-1506	30.78	181.75	11.65	143
	7.87	CLSG-1508	30.78	242.33	13.62	172
	9.84	CLSG-15010	30.78	302.92	15.59	203
	11.81	CLSG-15012	30.78	363.50	17.56	231
200 [206.1]	1.97	CLSG-2002	41.22	81.13	8.50	121
	5.91	CLSG-2006	41.22	243.40	12.44	201
	11.81	CLSG-20012	41.22	486.79	18.35	322
250 [284.0]	1.97	CLSG-2502	56.80	111.81	9.25	196
	5.91	CLSG-2506	56.80	335.42	13.19	300
	11.81	CLSG-25012	56.80	670.84	19.09	456
300 [353.6]	1.97	CLSG-3002	70.71	139.19	12.28	406
	5.91	CLSG-3006	70.71	417.56	16.22	511
	11.81	CLSG-30012	70.71	835.11	22.13	668
400 [433.9]	1.97	CLSG-4002	86.78	170.84	14.74	595
	5.91	CLSG-4006	86.78	512.51	18.68	728
	11.81	CLSG-40012	86.78	1025.02	24.59	928
500 [566.3]	1.97	CLSG-5002	113.25	222.92	16.50	884
	5.91	CLSG-5006	113.25	668.77	20.43	1058
	11.81	CLSG-50012	113.25	1337.55	26.34	1321
600 [662.9]	1.97	CLSG-6002	132.57	260.97	16.89	1045
	5.91	CLSG-6006	132.57	782.90	20.83	1246
	11.81	CLSG-60012	132.57	1565.81	26.73	1545
800 [911.6]	1.97	CLSG-8002	182.32	358.91	18.66	1634
	5.91	CLSG-8006	182.32	10776.72	22.60	1941
	11.81	CLSG-80012	182.32	2153.44	28.50	2332
1000 [1136]	1.97	CLSG-10002	227.19	447.23	22.20	2341
	5.91	CLSG-10006	227.19	1341.68	26.14	2674
	11.81	CLSG-100012	227.19	2683.35	32.05	3172

CLSG Series



Capacity:
50-1,000 tons

Stroke:
1.97-11.81 inches

Maximum Operating Pressure:
10,000 psi



Standard Features

- Interchangeable, hardened grooved saddles
- CR-400 Coupler and dust cap
- Top and side mount lifting eye capability
- All cylinders meet ASME B-30.1 and ISO 10100 Standards



Additional Stroke Lengths

Models above 150 tons are also available with standard stroke lengths of 4, 8 and 10 inches. Please contact Enerpac for ordering information and dimensional details.



Lifting an Unbalanced Load

When lifting an unbalanced load **Enerpac Synchronous Lift Systems** can be the solution with multiple lift point capabilities from 4 to 64 points. See our "Yellow Pages" for multi-cylinder set-ups.

CLSG-Series, High Tonnage Cylinders



Mounting Hole Orientation

Top mounting hole orientation is maintained to port location. Base mounting hole orientation is not maintained to port location.

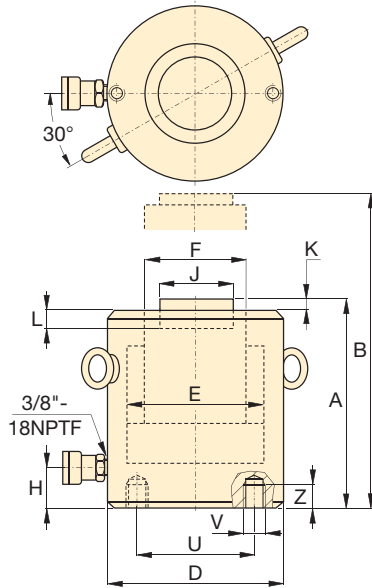

CLSG-50 to CLSG-150 models

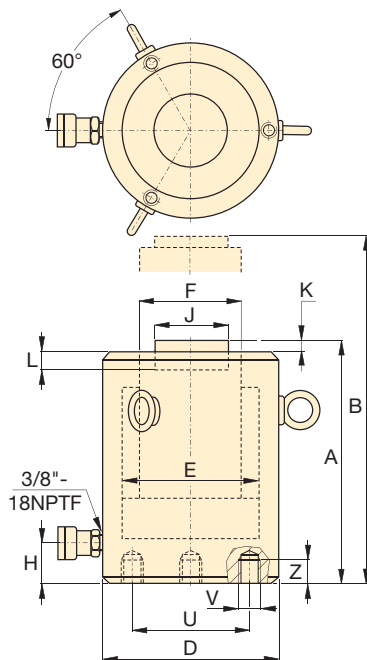

CLSG-200 to CLSG-1000 models

◀ For full features see page 36.

Cylinder Capacity (ton) [maximum]	Stroke (in)	Model Number	Cylinder Effective Area (in ²)	Oil Capacity (in ³)	Collapsed Height A (in)	Extended Height B (in)	Outside Diam. D (in)
50 [59.1]	1.97	CLSG-502	11.81	23.25	6.38	8.35	5.12
	3.94	CLSG-504	11.81	46.50	8.35	12.28	5.12
	5.91	CLSG-506	11.81	69.75	10.31	16.22	5.12
	7.87	CLSG-508	11.81	93.00	12.28	20.16	5.12
	9.84	CLSG-5010	11.81	116.25	14.25	24.09	5.12
11.81	CLSG-5012	11.81	139.50	16.22	28.03	5.12	
100 [102.9]	1.97	CLSG-1002	20.57	40.50	7.16	9.13	6.50
	3.94	CLSG-1004	20.57	81.00	9.13	13.06	6.50
	5.91	CLSG-1006	20.57	121.50	11.09	17.00	6.50
	7.87	CLSG-1008	20.57	162.00	13.06	20.94	6.50
	9.84	CLSG-10010	20.57	202.50	15.03	24.87	6.50
11.81	CLSG-10012	20.57	242.99	17.00	28.81	6.50	
150 [153.9]	1.97	CLSG-1502	30.78	60.58	7.72	9.69	8.07
	3.94	CLSG-1504	30.78	121.17	9.69	13.62	8.07
	5.91	CLSG-1506	30.78	181.75	11.65	17.56	8.07
	7.87	CLSG-1508	30.78	242.33	13.62	21.50	8.07
	9.84	CLSG-15010	30.78	302.92	15.59	25.43	8.07
11.81	CLSG-15012	30.78	363.50	17.56	29.37	8.07	
200 [206.1]	1.97	CLSG-2002	41.22	81.13	8.50	10.47	9.25
	5.91	CLSG-2006	41.22	243.40	12.44	18.35	9.25
	11.81	CLSG-20012	41.22	486.79	18.35	30.16	9.25
250 [284.0]	1.97	CLSG-2502	56.80	111.81	9.25	11.22	10.83
	5.91	CLSG-2506	56.80	335.42	13.19	19.09	10.83
	11.81	CLSG-25012	56.80	670.84	19.09	30.91	10.83
300 [353.6]	1.97	CLSG-3002	70.71	139.19	12.28	14.25	12.20
	5.91	CLSG-3006	70.71	417.56	16.22	22.13	12.20
	11.81	CLSG-30012	70.71	835.11	22.13	33.94	12.20
400 [433.9]	1.97	CLSG-4002	86.78	170.84	14.74	16.71	13.78
	5.91	CLSG-4006	86.78	512.51	18.68	24.59	13.78
	11.81	CLSG-40012	86.78	1025.02	24.59	36.40	13.78
500 [566.3]	1.97	CLSG-5002	113.25	222.92	16.50	18.46	15.75
	5.91	CLSG-5006	113.25	668.77	20.43	26.34	15.75
	11.81	CLSG-50012	113.25	1337.55	26.34	38.15	15.75
600 [662.9]	1.97	CLSG-6002	132.57	260.97	16.89	18.86	16.93
	5.91	CLSG-6006	132.57	782.90	20.83	26.73	16.93
	11.81	CLSG-60012	132.57	1565.81	26.73	38.54	16.93
800 [911.6]	1.97	CLSG-8002	182.32	358.91	18.66	20.63	19.88
	5.91	CLSG-8006	182.32	1076.72	22.60	28.50	19.88
	11.81	CLSG-80012	182.32	2153.44	28.50	40.31	19.88
1000 [1136]	1.97	CLSG-10002	227.19	447.23	22.20	24.17	22.05
	5.91	CLSG-10006	227.19	1341.68	26.14	32.05	22.05
	11.81	CLSG-100012	227.19	2683.35	32.05	43.86	22.05

Single-Acting, High Tonnage Cylinders

Optional Tilt Saddle *

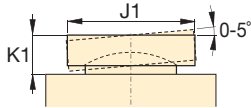

Capacity:
50-1,000 tons

Stroke:
1.97-11.81 inches

Maximum Operating Pressure:
10,000 psi

CLSG
Series



Cylinder Bore Diam.	Plunger Diam.	Base to Advance Port	Standard Saddle Diam.	Saddle Protrusion from Plngr.	Depth of Plunger Hole	Base Mounting Holes			Weight (lbs)	Model Number	* Optional Tilt Saddle		
						Bolt Cir. Diam.	Thread	Thread Depth			Diam.	Height	Model Number
E (in)	F (in)	H (in)	J (in)	K (in)	L (in)	U (in)	V (mm)	Z (in)		J1 (in)	K1 (in)		
3.88	2.76	2.05	1.97	.04	.75	2.56	M12	.87	37	CLSG-502	1.95	.94	CATG-50
3.88	2.76	2.05	1.97	.04	.75	2.56	M12	.87	44	CLSG-504	1.95	.94	CATG-50
3.88	2.76	2.05	1.97	.04	.75	2.56	M12	.87	51	CLSG-506	1.95	.94	CATG-50
3.88	2.76	2.05	1.97	.04	.75	2.56	M12	.87	60	CLSG-508	1.95	.94	CATG-50
3.88	2.76	2.05	1.97	.04	.75	2.56	M12	.87	68	CLSG-5010	1.95	.94	CATG-50
3.88	2.76	2.05	1.97	.04	.75	2.56	M12	.87	75	CLSG-5012	1.95	.94	CATG-50
5.12	3.74	2.13	2.95	.04	.75	3.74	M12	.87	42	CLSG-1002	2.87	1.14	CATG-100
5.12	3.74	2.13	2.95	.04	.75	3.74	M12	.87	64	CLSG-1004	2.87	1.14	CATG-100
5.12	3.74	2.13	2.95	.04	.75	3.74	M12	.87	88	CLSG-1006	2.87	1.14	CATG-100
5.12	3.74	2.13	2.95	.04	.75	3.74	M12	.87	110	CLSG-1008	2.87	1.14	CATG-100
5.12	3.74	2.13	2.95	.04	.75	3.74	M12	.87	134	CLSG-10010	2.87	1.14	CATG-100
5.12	3.74	2.13	2.95	.04	.75	3.74	M12	.87	157	CLSG-10012	2.87	1.14	CATG-100
6.26	4.49	2.40	3.70	.04	.75	5.12	M12	.87	86	CLSG-1502	3.57	1.22	CATG-150
6.26	4.49	2.40	3.70	.04	.75	5.12	M12	.87	115	CLSG-1504	3.57	1.22	CATG-150
6.26	4.49	2.40	3.70	.04	.75	5.12	M12	.87	143	CLSG-1506	3.57	1.22	CATG-150
6.26	4.49	2.40	3.70	.04	.75	5.12	M12	.87	172	CLSG-1508	3.57	1.22	CATG-150
6.26	4.49	2.40	3.70	.04	.75	5.12	M12	.87	203	CLSG-15010	3.57	1.22	CATG-150
6.26	4.49	2.40	3.70	.04	.75	5.12	M12	.87	231	CLSG-15012	3.57	1.22	CATG-150
7.24	5.24	2.62	4.45	.04	.94	6.50	M12	.87	121	CLSG-2002	4.64	1.37	CATG-200
7.24	5.24	2.62	4.45	.04	.94	6.50	M12	.87	201	CLSG-2006	4.64	1.37	CATG-200
7.24	5.24	2.62	4.45	.04	.94	6.50	M12	.87	322	CLSG-20012	4.64	1.37	CATG-200
8.50	6.50	2.87	5.71	.04	.94	7.48	M12	.87	196	CLSG-2502	5.67	1.81	CATG-250
8.50	6.50	2.87	5.71	.04	.94	7.48	M12	.87	300	CLSG-2506	5.67	1.81	CATG-250
8.50	6.50	2.87	5.71	.04	.94	7.48	M12	.87	456	CLSG-25012	5.67	1.81	CATG-250
9.49	7.76	3.98	6.97	.04	.75	7.09	M16	1.42	406	CLSG-3002	6.30	2.43	CATG-300
9.49	7.76	3.98	6.97	.04	.75	7.09	M16	1.42	511	CLSG-3006	6.30	2.43	CATG-300
9.49	7.76	3.98	6.97	.04	.75	7.09	M16	1.42	668	CLSG-30012	6.30	2.43	CATG-300
10.51	8.50	4.49	7.72	.12	1.06	8.07	M16	1.42	595	CLSG-4002	7.59	2.32	CATG-400
10.51	8.50	4.49	7.72	.12	1.06	8.07	M16	1.42	728	CLSG-4006	7.59	2.32	CATG-400
10.51	8.50	4.49	7.72	.12	1.06	8.07	M16	1.42	928	CLSG-40012	7.59	2.32	CATG-400
12.01	9.76	4.49	8.98	.12	1.06	9.84	M24	1.50	884	CLSG-5002	8.98	2.48	CATG-500
12.01	9.76	4.49	8.98	.12	1.06	9.84	M24	1.50	1058	CLSG-5006	8.98	2.48	CATG-500
12.01	9.76	4.49	8.98	.12	1.06	9.84	M24	1.50	1321	CLSG-50012	8.98	2.48	CATG-500
12.99	10.51	4.49	9.72	.12	1.06	10.83	M24	1.50	1045	CLSG-6002	9.47	3.08	CATG-600
12.99	10.51	4.49	9.72	.12	1.06	10.83	M24	1.50	1246	CLSG-6006	9.47	3.08	CATG-600
12.99	10.51	4.49	9.72	.12	1.06	10.83	M24	1.50	1545	CLSG-60012	9.47	3.08	CATG-600
15.24	12.48	5.87	11.69	.12	1.06	12.99	M24	1.50	1634	CLSG-8002	11.28	3.41	CATG-800
15.24	12.48	5.87	11.69	.12	1.06	12.99	M24	1.50	1914	CLSG-8006	11.28	3.41	CATG-800
15.24	12.48	5.87	11.69	.12	1.06	12.99	M24	1.50	2332	CLSG-80012	11.28	3.41	CATG-800
17.01	13.50	6.85	12.72	.12	1.06	14.76	M24	1.50	2341	CLSG-10002	12.26	3.65	CATG-1000
17.01	13.50	6.85	12.72	.12	1.06	14.76	M24	1.50	2674	CLSG-10006	12.26	3.65	CATG-1000
17.01	13.50	6.85	12.72	.12	1.06	14.76	M24	1.50	3172	CLSG-100012	12.26	3.65	CATG-1000

▼ Shown from left to right: CLRG-506, CLRG-2006, CLRG-1506



- Integral stop ring provides piston blow-out protection
- Double-acting for positive retraction
- Baked enamel outside finish and plated pistons provide superior corrosion resistance
- Safety valve in retract side of cylinder helps to prevent damage in case of accidental over-pressurization
- Interchangeable, hardened grooved saddles are standard
- Plunger wiper reduces contamination, extending cylinder life

▼ CLRG-Series cylinders supported and positioned these automobile deck elements.



Double-Acting Power Lifters



Saddles

All CLRG cylinders are equipped with bolt-on removable grooved saddles. For information on optional tilt saddles, see selection chart.

Page: 43



Safety Device

A pilot-operated check valve (V-42) can be inserted between cylinder ports.

This valve provides a safety lock on the cylinder under load at any position and remote control for unlocking.

Page: 129



Optimum Performance

Enerpac's range of Z-Class electric pumps, fitted with manual or solenoid operated 4-way valves, offer optimum combinations with CLRG cylinders.

Page: 76

▼ Replacing adjustment rolls under a fly-over with CLRG cylinders, for controlled lifting and lowering.



Double-Acting, High Tonnage Cylinders

▼ QUICK SELECTION CHART

For complete technical information see next page.

Cylinder Capacity (ton)	Stroke (in)	Model Number	Cylinder Effective Area (in ²)		Oil Capacity (in ³)		Collapsed Height (in)
			Push	Pull	Push	Pull	
			50	1.97	CLRG-502	11.81	
	3.94	CLRG-504	11.81	5.85	46.50	23.02	8.35
	5.91	CLRG-506	11.81	5.85	69.75	34.52	10.31
	7.87	CLRG-508	11.81	5.85	93.00	46.03	12.28
	9.84	CLRG-5010	11.81	5.85	116.25	57.54	14.25
	11.81	CLRG-5012	11.81	5.85	139.50	69.05	16.22
100	1.97	CLRG-1002	20.57	9.59	40.50	18.87	7.16
	3.94	CLRG-1004	20.57	9.59	81.00	37.74	9.13
	5.91	CLRG-1006	20.57	9.59	121.50	56.61	11.09
	7.87	CLRG-1008	20.57	9.59	162.00	75.49	13.06
	9.84	CLRG-10010	20.57	9.59	202.50	94.36	15.03
	11.81	CLRG-10012	20.57	9.59	242.99	113.23	17.00
150	1.97	CLRG-1502	30.78	14.96	60.58	29.44	7.72
	3.94	CLRG-1504	30.78	14.96	121.17	58.88	9.69
	5.91	CLRG-1506	30.78	14.96	181.75	88.32	11.65
	7.87	CLRG-1508	30.78	14.96	242.33	117.76	13.62
	9.84	CLRG-15010	30.78	14.96	302.92	147.20	15.59
	11.81	CLRG-15012	30.78	14.96	363.50	176.64	17.56
200	1.97	CLRG-2002	41.22	19.68	81.13	38.74	8.50
	5.91	CLRG-2006	41.22	19.68	243.40	116.23	12.44
	11.81	CLRG-20012	41.22	19.68	486.79	232.46	18.35
250	1.97	CLRG-2502	56.80	23.65	111.81	46.56	9.25
	5.91	CLRG-2506	56.80	23.65	335.42	139.69	13.19
	11.81	CLRG-25012	56.80	23.65	670.84	279.39	19.09
300	1.97	CLRG-3002	70.71	23.46	139.19	46.18	12.28
	5.91	CLRG-3006	70.71	23.46	417.56	138.55	16.22
	11.81	CLRG-30012	70.71	23.46	835.11	277.10	22.13
400	1.97	CLRG-4002	86.79	29.99	170.84	59.03	14.74
	5.91	CLRG-4006	86.79	29.99	512.51	177.09	18.68
	11.81	CLRG-40012	86.79	29.99	1,025	354.18	24.59
500	1.97	CLRG-5002	113.25	38.37	222.92	75.54	16.50
	5.91	CLRG-5006	113.25	38.37	668.77	226.61	20.43
	11.81	CLRG-50012	113.25	38.37	1,338	453.22	26.34
600	1.97	CLRG-6002	132.57	45.79	260.97	90.13	16.89
	5.91	CLRG-6006	132.57	45.79	782.90	270.39	20.83
	11.81	CLRG-60012	132.57	45.79	1,566	540.79	26.73
800	1.97	CLRG-8002	182.32	59.99	358.91	118.09	18.66
	5.91	CLRG-8006	182.32	59.99	1,077	354.28	22.60
	11.81	CLRG-80012	182.32	59.99	2,153	708.57	28.50
1000	1.97	CLRG-10002	227.19	83.97	447.23	165.29	22.20
	5.91	CLRG-10006	227.19	83.97	1,342	495.87	26.14
	11.81	CLRG-100012	227.19	83.97	2,683	991.75	32.05

CLRG Series



Capacity:
50-1,000 tons

Stroke:
1.97-11.81 inches

Maximum Operating Pressure:
10,000 psi



Standard Features

- Interchangeable, hardened grooved saddles
- CR-400 Coupler and dust cap
- Top and side mount lifting eye capability
- All cylinders meet ASME B-30.1 and ISO 10100 Standards



Pump Selection

A double-acting cylinder must be powered by a pump with a 4-way valve.

Page: 57



RR-Series

For higher cycle applications, Enerpac RR cylinders are a good alternative.

Page: 32



Additional Stroke Lengths

Models above 150 tons are also available with standard stroke lengths of 4, 8 and 10 inches. Please contact Enerpac for ordering information.

CLRG-Series, High Tonnage Cylinders

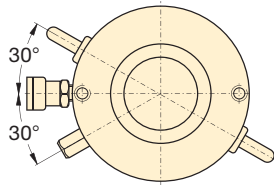

Mounting Hole Orientation

Top mounting hole orientation is maintained to port location. Base mounting hole orientation is not maintained to port location.

◀ For full features see page 40.

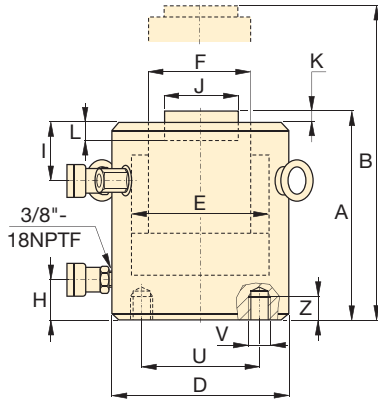

CLRG-50 to CLRG-150 models

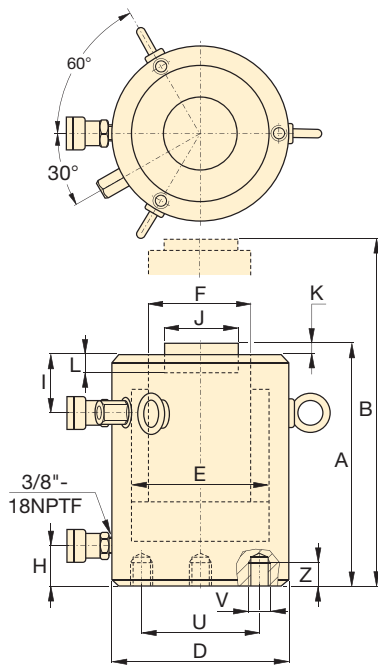

CLRG-200 to CLRG-1000 models

Base Mounting Hole Dimensions (in)			
Model / Capacity ton	Bolt Circle U	Thread Size V (mm)	Minimum Thread Depth Z
CLRG-50	2.56	M12	.87
CLRG-100	3.74	M12	.87
CLRG-150	5.12	M12	.87
CLRG-200	6.50	M12	.87
CLRG-250	7.48	M12	.87
CLRG-300	7.09	M16	1.42
CLRG-400	8.07	M16	1.42
CLRG-500	9.84	M24	1.50
CLRG-600	10.83	M24	1.50
CLRG-800	12.99	M24	1.50
CLRG-1000	14.76	M24	1.50

Cylinder Capacity (ton)	Stroke (in)	Model Number	Maximum Cylinder Capacity (ton)		Cylinder Effective Area (in ²)		Oil Capacity (in ³)	
			Push	Pull	Push	Pull	Push	Pull
50	1.97	CLRG-502	59.1	29	11.81	5.85	23.25	11.51
	3.94	CLRG-504	59.1	29	11.81	5.85	46.50	23.02
	5.91	CLRG-506	59.1	29	11.81	5.85	69.75	34.52
	7.87	CLRG-508	59.1	29	11.81	5.85	93.00	46.03
	9.84	CLRG-5010	59.1	29	11.81	5.85	116.25	57.54
11.81	CLRG-5012	59.1	29	11.81	5.85	139.50	69.05	
100	1.97	CLRG-1002	102.9	48	20.57	9.59	40.50	18.87
	3.94	CLRG-1004	102.9	48	20.57	9.59	81.00	37.74
	5.91	CLRG-1006	102.9	48	20.57	9.59	121.50	56.61
	7.87	CLRG-1008	102.9	48	20.57	9.59	162.00	75.49
	9.84	CLRG-10010	102.9	48	20.57	9.59	202.50	94.36
11.81	CLRG-10012	102.9	48	20.57	9.59	242.99	113.23	
150	1.97	CLRG-1502	153.9	75	30.78	14.96	60.58	29.44
	3.94	CLRG-1504	153.9	75	30.78	14.96	121.17	58.88
	5.91	CLRG-1506	153.9	75	30.78	14.96	181.75	88.32
	7.87	CLRG-1508	153.9	75	30.78	14.96	242.33	117.76
	9.84	CLRG-15010	153.9	75	30.78	14.96	302.92	147.20
11.81	CLRG-15012	153.9	75	30.78	14.96	363.50	176.64	
200	1.97	CLRG-2002	206.1	98	41.22	19.68	81.13	38.74
	5.91	CLRG-2006	206.1	98	41.22	19.68	243.40	116.23
	11.81	CLRG-20012	206.1	98	41.22	19.68	486.79	232.46
250	1.97	CLRG-2502	284.0	118	56.80	23.65	111.81	46.56
	5.91	CLRG-2506	284.0	118	56.80	23.65	335.42	139.69
	11.81	CLRG-25012	284.0	118	56.80	23.65	670.84	279.39
300	1.97	CLRG-3002	353.6	117	70.71	23.46	139.19	46.18
	5.91	CLRG-3006	353.6	117	70.71	23.46	417.56	138.55
	11.81	CLRG-30012	353.6	117	70.71	23.46	835.11	277.10
400	1.97	CLRG-4002	433.9	150	86.79	29.99	170.84	59.03
	5.91	CLRG-4006	433.9	150	86.79	29.99	512.51	177.09
	11.81	CLRG-40012	433.9	150	86.79	29.99	1,025	354.18
500	1.97	CLRG-5002	566.3	192	113.25	38.37	222.92	75.54
	5.91	CLRG-5006	566.3	192	113.25	38.37	668.77	226.61
	11.81	CLRG-50012	566.3	192	113.25	38.37	1,338	453.22
600	1.97	CLRG-6002	662.9	229	132.57	45.79	260.97	90.13
	5.91	CLRG-6006	662.9	229	132.57	45.79	782.90	270.39
	11.81	CLRG-60012	662.9	229	132.57	45.79	1,566	540.79
800	1.97	CLRG-8002	911.6	300	182.32	59.99	358.91	118.09
	5.91	CLRG-8006	911.6	300	182.32	59.99	1,077	354.28
	11.81	CLRG-80012	911.6	300	182.32	59.99	2,153	708.57
1000	1.97	CLRG-10002	1136	420	227.19	83.97	447.23	165.29
	5.91	CLRG-10006	1136	420	227.19	83.97	1,342	495.87
	11.81	CLRG-100012	1136	420	227.19	83.97	2,683	991.75

Double-Acting, High Tonnage Cylinders

* Optional Tilt Saddle

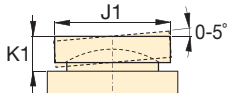

Capacity:

50-1,000 tons

Stroke:

1.97-11.81 inches

Maximum Operating Pressure:

10,000 psi

CLRG Series



Collap. Height	Ext. Height	Outside Diam.	Cyl. Bore Diam.	Plunger Diam.	Base to Advance Port	Top to Retract Port	Standard Saddle Diam.	Saddle Protrusion from Plngr.	Depth of Plunger Hole	Weight (lbs)	Model Number	*Optional Tilt Saddle		
												Diam.	Height	Model Number
A (in)	B (in)	D (in)	E (in)	F (in)	H (in)	I (in)	J (in)	K (in)	L (in)	(lbs)		J1 (in)	K1 (in)	
6.38	8.35	5.12	3.88	2.76	1.65	1.29	1.97	.04	.75	37	CLRG-502	1.95	.94	CATG-50
8.35	12.28	5.12	3.88	2.76	1.65	1.29	1.97	.04	.75	44	CLRG-504	1.95	.94	CATG-50
10.31	16.22	5.12	3.88	2.76	1.65	1.29	1.97	.04	.75	51	CLRG-506	1.95	.94	CATG-50
12.28	20.16	5.12	3.88	2.76	1.65	1.29	1.97	.04	.75	60	CLRG-508	1.95	.94	CATG-50
14.25	24.09	5.12	3.88	2.76	1.65	1.29	1.97	.04	.75	68	CLRG-5010	1.95	.94	CATG-50
16.22	28.03	5.12	3.88	2.76	1.65	1.29	1.97	.04	.75	75	CLRG-5012	1.95	.94	CATG-50
7.16	9.13	6.50	5.12	3.74	2.13	1.89	2.95	.04	.75	42	CLRG-1002	2.87	1.14	CATG-100
9.13	13.06	6.50	5.12	3.74	2.13	1.89	2.95	.04	.75	64	CLRG-1004	2.87	1.14	CATG-100
11.09	17.00	6.50	5.12	3.74	2.13	1.89	2.95	.04	.75	88	CLRG-1006	2.87	1.14	CATG-100
13.06	20.94	6.50	5.12	3.74	2.13	1.89	2.95	.04	.75	110	CLRG-1008	2.87	1.14	CATG-100
15.03	24.87	6.50	5.12	3.74	2.13	1.89	2.95	.04	.75	134	CLRG-10010	2.87	1.14	CATG-100
17.00	28.81	6.50	5.12	3.74	2.13	1.89	2.95	.04	.75	157	CLRG-10012	2.87	1.14	CATG-100
7.72	9.69	8.07	6.26	4.49	2.40	2.22	3.70	.04	.75	86	CLRG-1502	3.57	1.22	CATG-150
9.69	13.62	8.07	6.26	4.49	2.40	2.22	3.70	.04	.75	115	CLRG-1504	3.57	1.22	CATG-150
11.65	17.56	8.07	6.26	4.49	2.40	2.22	3.70	.04	.75	143	CLRG-1506	3.57	1.22	CATG-150
13.62	21.50	8.07	6.26	4.49	2.40	2.22	3.70	.04	.75	172	CLRG-1508	3.57	1.22	CATG-150
15.59	25.43	8.07	6.26	4.49	2.40	2.22	3.70	.04	.75	203	CLRG-15010	3.57	1.22	CATG-150
17.56	29.37	8.07	6.26	4.49	2.40	2.22	3.70	.04	.75	231	CLRG-15012	3.57	1.22	CATG-150
8.50	10.47	9.25	7.24	5.24	2.62	2.22	4.45	.04	.94	121	CLRG-2002	4.64	1.37	CATG-200
12.44	18.35	9.25	7.24	5.24	2.62	2.22	4.45	.04	.94	201	CLRG-2006	4.64	1.37	CATG-200
18.35	30.16	9.25	7.24	5.24	2.62	2.22	4.45	.04	.94	322	CLRG-20012	4.64	1.37	CATG-200
9.25	11.22	10.83	8.50	6.50	2.87	3.07	5.71	.04	.94	196	CLRG-2502	5.67	1.81	CATG-250
13.19	19.09	10.83	8.50	6.50	2.87	3.07	5.71	.04	.94	300	CLRG-2506	5.67	1.81	CATG-250
19.09	30.91	10.83	8.50	6.50	2.87	3.07	5.71	.04	.94	456	CLRG-25012	5.67	1.81	CATG-250
12.68	14.25	12.20	9.49	7.76	3.98	2.95	6.97	.04	.75	406	CLRG-3002	6.30	2.43	CATG-300
16.22	22.13	12.20	9.49	7.76	3.98	2.95	6.97	.04	.75	511	CLRG-3006	6.30	2.43	CATG-300
22.13	33.94	12.20	9.49	7.76	3.98	2.95	6.97	.04	.75	668	CLRG-30012	6.30	2.43	CATG-300
14.74	16.71	13.78	10.51	8.50	4.49	4.13	7.72	.12	1.06	595	CLRG-4002	7.59	2.32	CATG-400
18.68	24.59	13.78	10.51	8.50	4.49	4.13	7.72	.12	1.06	728	CLRG-4006	7.59	2.32	CATG-400
24.59	36.40	13.78	10.51	8.50	4.49	4.13	7.72	.12	1.06	928	CLRG-40012	7.59	2.32	CATG-400
16.50	18.46	15.75	12.01	9.76	4.49	5.31	8.98	.12	1.06	884	CLRG-5002	8.98	2.48	CATG-500
20.43	26.34	15.75	12.01	9.76	4.49	5.31	8.98	.12	1.06	1058	CLRG-5006	8.98	2.48	CATG-500
26.34	38.15	15.75	12.01	9.76	4.49	5.31	8.98	.12	1.06	1321	CLRG-50012	8.98	2.48	CATG-500
16.89	18.86	16.93	12.99	10.51	4.49	5.31	9.72	.12	1.06	1045	CLRG-6002	9.47	3.08	CATG-600
20.83	26.73	16.93	12.99	10.51	4.49	5.31	9.72	.12	1.06	1246	CLRG-6006	9.47	3.08	CATG-600
26.73	38.54	16.93	12.99	10.51	4.49	5.31	9.72	.12	1.06	1545	CLRG-60012	9.47	3.08	CATG-600
18.66	20.63	19.88	15.24	12.48	5.87	5.31	11.69	.12	1.06	1634	CLRG-8002	11.28	3.41	CATG-800
22.60	28.50	19.88	15.24	12.48	5.87	5.31	11.69	.12	1.06	1914	CLRG-8006	11.28	3.41	CATG-800
28.50	40.31	19.88	15.24	12.48	5.87	5.31	11.69	.12	1.06	2332	CLRG-80012	11.28	3.41	CATG-800
22.20	24.17	22.05	17.01	13.50	6.85	6.69	12.72	.12	1.06	2341	CLRG-10002	12.26	3.65	CATG-1000
26.14	32.05	22.05	17.01	13.50	6.85	6.69	12.72	.12	1.06	2674	CLRG-10006	12.26	3.65	CATG-1000
32.05	43.86	22.05	17.01	13.50	6.85	6.69	12.72	.12	1.06	3172	CLRG-100012	12.26	3.65	CATG-1000

▼ Shown from left to right: CLL-1006, CLL-2506, CLL-1506, CLL-506



- **Safety Lock Nut for mechanical load holding**
- **Baked enamel outside finish and plated pistons provide superior corrosion resistance**
- **Overflow port functions as a stroke limiter**
- **Interchangeable, hardened grooved saddles are standard**
- **CR-400 coupler and dust cap included on all models**
- **Single-acting load return**

▼ For this curved bridge, CLL-Series cylinders were used to support the concrete beams to level the pierhead and to place 4000 ton slide bearings between pier and pierhead.



To Secure Loads Mechanically



Saddles

All CLL cylinders are equipped with bolt-on removable grooved saddles. For information on optional tilt saddles, see the selection chart.

Page: 47



Gauges

Minimize the risk of overloading and ensure long, dependable service from your equipment. Refer to the System Components section for a full range of gauges.

Page: 113



Low Height - High Tonnage

When low height with high force is required, pancake cylinders with lock nut offer the solution to lift the first few inches.

Page: 20

▼ CLL cylinder, mechanically locked, after positioning the curved bridge.



Single-Acting, Lock Nut Cylinders

▼ QUICK SELECTION CHART

For complete technical information see next page.

Cylinder Capacity	Stroke	Model Number	Cylinder Effective Area	Oil Capacity	Collapsed Height	Weight
(ton) [maximum]	(in)		(in ²)	(in ³)	(in)	(lbs)
50 [59.1]	1.97	CLL-502	10.99	21.63	6.46	35
	3.94	CLL-504	10.99	43.25	8.43	46
	5.91	CLL-506	10.99	64.88	10.39	57
	7.87	CLL-508	10.99	86.51	12.36	68
	9.84	CLL-5010	10.99	108.14	14.33	79
	11.81	CLL-5012	10.99	129.76	16.30	90
100 [102.9]	1.97	CLL-1002	20.57	40.50	7.36	68
	3.94	CLL-1004	20.57	81.00	9.33	87
	5.91	CLL-1006	20.57	121.50	11.30	106
	7.87	CLL-1008	20.57	162.00	13.27	125
	9.84	CLL-10010	20.57	202.50	15.24	143
	11.81	CLL-10012	20.57	242.99	17.20	162
150 [153.9]	1.97	CLL-1502	30.78	60.58	8.23	117
	3.94	CLL-1504	30.78	121.17	10.20	146
	5.91	CLL-1506	30.78	181.75	12.17	174
	7.87	CLL-1508	30.78	242.33	14.13	203
	9.84	CLL-15010	30.78	302.92	16.10	231
	11.81	CLL-15012	30.78	363.50	18.07	260
200 [206.1]	1.97	CLL-2002	41.17	81.04	9.57	183
	5.91	CLL-2006	41.17	243.13	13.50	260
	11.81	CLL-20012	41.17	486.27	19.41	376
250 [284.0]	1.97	CLL-2502	56.75	111.70	9.80	256
	5.91	CLL-2506	56.75	335.11	13.74	359
	11.81	CLL-25012	56.75	670.22	19.65	515
300 [353.6]	1.97	CLL-3002	70.71	139.19	11.61	382
	5.91	CLL-3006	70.71	417.56	15.55	514
	11.81	CLL-30012	70.71	835.11	21.46	712
400 [433.9]	1.97	CLL-4002	86.79	170.84	13.19	553
	5.91	CLL-4006	86.79	512.51	17.13	721
	11.81	CLL-40012	86.79	1025.02	23.03	972
500 [566.3]	1.97	CLL-5002	113.25	222.99	14.76	809
	5.91	CLL-5006	113.25	668.77	18.70	1029
	11.81	CLL-50012	113.25	1337.55	24.61	1360
600 [662.9]	1.97	CLL-6002	132.57	260.97	15.55	985
	5.91	CLL-6006	132.57	782.90	19.49	1241
	11.81	CLL-60012	132.57	1565.81	25.39	1625
800 [911.6]	1.97	CLL-8002	182.42	359.09	17.91	1565
	5.91	CLL-8006	182.42	1077.27	21.85	1918
	11.81	CLL-80012	182.42	2154.55	27.76	2446
1000 [1136]	1.97	CLL-10002	227.30	447.43	19.49	2094
	5.91	CLL-10006	227.30	1342.30	23.43	2517
	11.81	CLL-100012	227.30	2684.59	29.33	3151

CLL Series



Capacity:

50-1,000 tons

Stroke:

1.97-11.81 inches

Maximum Operating Pressure:

10,000 psi



Additional Stroke Lengths

Models above 150 tons are also available with standard stroke lengths of 4, 8 and 10 inches. Please contact Enerpac for ordering information and dimensional details.



Lifting an Unbalanced Load?

See our "Yellow Pages" for multi-cylinder set ups.

Page: **242**



Speed Chart

See the Enerpac Cylinder Speed Chart in our "Yellow Pages" section.

Page: **251**

CLL-Series, Lock Nut Cylinders

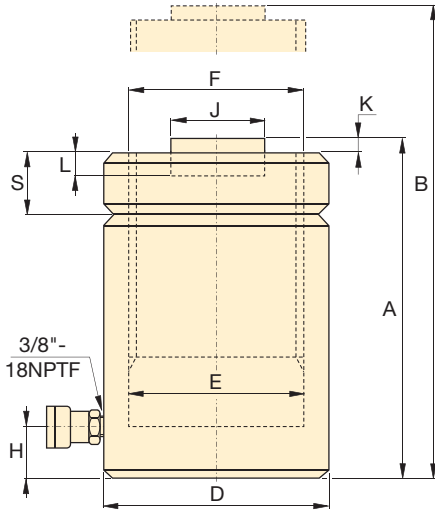
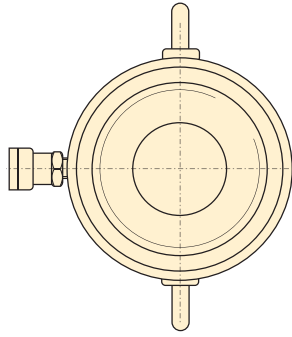

CLL-50 to CLL-250 models

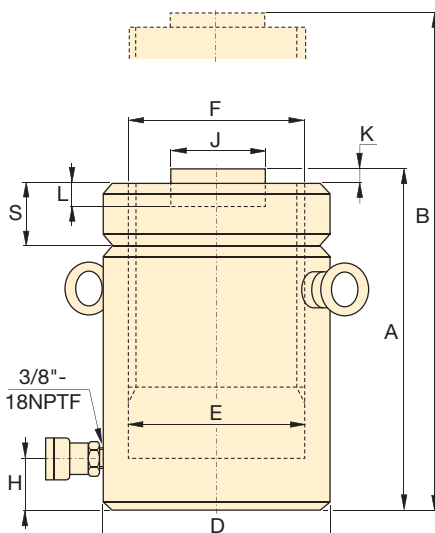
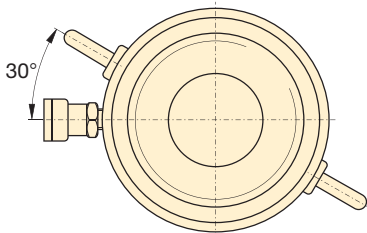

CLL-300 to CLL-1000 models

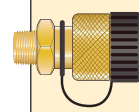

Coupler Included!

CR-400 coupler included on all models.
Fits all HC-Series hoses.

◀ For full features see page 44.

Cylinder Capacity (ton) [maximum]	Stroke (in)	Model Number	Cylinder Effective Area (in ²)	Oil Capacity (in ³)
50 [59.1]	1.97	CLL-502	10.99	21.63
	3.94	CLL-504	10.99	43.25
	5.91	CLL-506	10.99	64.88
	7.87	CLL-508	10.99	86.51
	9.84	CLL-5010	10.99	108.14
100 [102.9]	11.81	CLL-5012	10.99	129.76
	1.97	CLL-1002	20.57	40.50
	3.94	CLL-1004	20.57	81.00
	5.91	CLL-1006	20.57	121.50
	7.87	CLL-1008	20.57	162.00
150 [153.9]	9.84	CLL-10010	20.57	202.50
	11.81	CLL-10012	20.57	242.99
	1.97	CLL-1502	30.78	60.58
	3.94	CLL-1504	30.78	121.17
	5.91	CLL-1506	30.78	181.75
200 [206.1]	7.87	CLL-1508	30.78	242.33
	9.84	CLL-15010	30.78	302.92
	11.81	CLL-15012	30.78	363.50
250 [284.0]	1.97	CLL-2002	41.17	81.04
	5.91	CLL-2006	41.17	243.13
	11.81	CLL-20012	41.17	486.27
300 [353.6]	1.97	CLL-2502	56.75	111.70
	5.91	CLL-2506	56.75	335.11
	11.81	CLL-25012	56.75	670.22
400 [433.9]	1.97	CLL-3002	70.71	139.19
	5.91	CLL-3006	70.71	417.56
	11.81	CLL-30012	70.71	835.11
500 [566.3]	1.97	CLL-4002	86.79	170.84
	5.91	CLL-4006	86.79	512.51
	11.81	CLL-40012	86.79	1025.02
600 [662.9]	1.97	CLL-5002	113.25	222.99
	5.91	CLL-5006	113.25	668.77
	11.81	CLL-50012	113.25	1337.55
800 [911.6]	1.97	CLL-6002	132.57	260.97
	5.91	CLL-6006	132.57	782.90
	11.81	CLL-60012	132.57	1565.81
1000 [1136]	1.97	CLL-8002	182.42	359.09
	5.91	CLL-8006	182.42	1077.27
	11.81	CLL-80012	182.42	2154.55
	1.97	CLL-10002	227.30	447.43
	5.91	CLL-10006	227.30	1342.30
	11.81	CLL-100012	227.30	2684.59

Single-Acting, Lock Nut Cylinders

*Optional Tilt Saddle

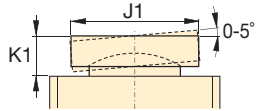

Capacity:

50-1,000 tons

Stroke:

1.97-11.81 inches

Maximum Operating Pressure:

10,000 psi

**CLL
Series**



Collap. Height	Ext. Height	Outside Diam.	Cyl. Bore Diam.	Plunger Diameter (threaded)	Base to Advance Port	Stand. Saddle Diam.	Saddle Protrusion from Plgr.	Depth of Plunger Hole	Lock Nut Height	Weight (lbs)	Model Number	* Optional Tilt Saddle		
												Diam. J1 (in)	Height K1 (in)	Model Number
A (in)	B (in)	D (in)	E (in)	F (mm)	H (in)	J (in)	K (in)	L (in)	S (in)			J1 (in)	K1 (in)	
6.46	8.43	4.92	3.74	Tr 95 x 4	1.18	2.80	.08	.51	1.42	35	CLL-502	2.80	.94	CAT-100
8.43	12.36	4.92	3.74	Tr 95 x 4	1.18	2.80	.08	.51	1.42	46	CLL-504	2.80	.94	CAT-100
10.39	16.30	4.92	3.74	Tr 95 x 4	1.18	2.80	.08	.51	1.42	57	CLL-506	2.80	.94	CAT-100
12.36	20.24	4.92	3.74	Tr 95 x 4	1.18	2.80	.08	.51	1.42	68	CLL-508	2.80	.94	CAT-100
14.33	24.17	4.92	3.74	Tr 95 x 4	1.18	2.80	.08	.51	1.42	79	CLL-5010	2.80	.94	CAT-100
16.30	28.11	4.92	3.74	Tr 95 x 4	1.18	2.80	.08	.51	1.42	90	CLL-5012	2.80	.94	CAT-100
7.36	9.33	6.50	5.12	Tr 130 x 6	1.18	2.80	.08	.51	1.73	68	CLL-1002	2.80	.94	CAT-100
9.33	13.27	6.50	5.12	Tr 130 x 6	1.18	2.80	.08	.51	1.73	87	CLL-1004	2.80	.94	CAT-100
11.30	17.20	6.50	5.12	Tr 130 x 6	1.18	2.80	.08	.51	1.73	106	CLL-1006	2.80	.94	CAT-100
13.27	21.14	6.50	5.12	Tr 130 x 6	1.18	2.80	.08	.51	1.73	125	CLL-1008	2.80	.94	CAT-100
15.24	25.08	6.50	5.12	Tr 130 x 6	1.18	2.80	.08	.51	1.73	143	CLL-10010	2.80	.94	CAT-100
17.20	29.02	6.50	5.12	Tr 130 x 6	1.18	2.80	.08	.51	1.73	162	CLL-10012	2.80	.94	CAT-100
8.23	10.20	8.07	6.26	Tr 159 x 6	1.54	5.12	.08	.98	1.73	117	CLL-1502	5.12	.79	CAT-200
10.20	14.13	8.07	6.26	Tr 159 x 6	1.54	5.12	.08	.98	1.73	146	CLL-1504	5.12	.79	CAT-200
12.17	18.07	8.07	6.26	Tr 159 x 6	1.54	5.12	.08	.98	1.73	174	CLL-1506	5.12	.79	CAT-200
14.13	22.01	8.07	6.26	Tr 159 x 6	1.54	5.12	.08	.98	1.73	203	CLL-1508	5.12	.79	CAT-200
16.10	25.94	8.07	6.26	Tr 159 x 6	1.54	5.12	.08	.98	1.73	231	CLL-15010	5.12	.79	CAT-200
18.07	29.88	8.07	6.26	Tr 159 x 6	1.54	5.12	.08	.98	1.73	260	CLL-15012	5.12	.79	CAT-200
9.57	11.54	9.25	7.24	Tr 184 x 6	1.97	5.12	.08	.98	1.97	183	CLL-2002	5.12	.79	CAT-200
13.50	19.41	9.25	7.24	Tr 184 x 6	1.97	5.12	.08	.98	1.97	260	CLL-2006	5.12	.79	CAT-200
19.41	31.22	9.25	7.24	Tr 184 x 6	1.97	5.12	.08	.98	1.97	376	CLL-20012	5.12	.79	CAT-200
9.80	11.77	10.83	8.50	Tr 216 x 6	1.97	5.91	.08	.98	2.20	256	CLL-2502	5.91	.83	CAT-250
13.74	19.65	10.83	8.50	Tr 216 x 6	1.97	5.91	.08	.98	2.20	359	CLL-2506	5.91	.83	CAT-250
19.65	31.46	10.83	8.50	Tr 216 x 6	1.97	5.91	.08	.98	2.20	515	CLL-25012	5.91	.83	CAT-250
11.61	13.58	12.20	9.49	Tr 241 x 6	2.32	5.47	.20	.98	2.36	382	CLL-3002	7.68	2.95	CAT-300
15.55	21.46	12.20	9.49	Tr 241 x 6	2.32	5.47	.20	.98	2.36	514	CLL-3006	7.68	2.95	CAT-300
21.46	33.27	12.20	9.49	Tr 241 x 6	2.32	5.47	.20	.98	2.36	712	CLL-30012	7.68	2.95	CAT-300
13.19	15.16	13.78	10.51	Tr 266 x 6	2.76	6.26	.20	.98	2.76	553	CLL-4002	8.86	3.35	CAT-400
17.13	23.03	13.78	10.51	Tr 266 x 6	2.76	6.26	.20	.98	2.76	721	CLL-4006	8.86	3.35	CAT-400
23.03	34.84	13.78	10.51	Tr 266 x 6	2.76	6.26	.20	.98	2.76	972	CLL-40012	8.86	3.35	CAT-400
14.76	16.73	15.75	12.01	Tr 305 x 6	3.15	7.05	.20	.98	3.15	809	CLL-5002	9.84	3.58	CAT-500
18.70	24.61	15.75	12.01	Tr 305 x 6	3.15	7.05	.20	.98	3.15	1029	CLL-5006	9.84	3.58	CAT-500
24.61	36.42	15.75	12.01	Tr 305 x 6	3.15	7.05	.20	.98	3.15	1360	CLL-50012	9.84	3.58	CAT-500
15.55	17.52	16.93	12.99	Tr 330 x 6	3.35	7.64	.20	.98	3.35	985	CLL-6002	10.83	3.78	CAT-600
19.49	25.39	16.93	12.99	Tr 330 x 6	3.35	7.64	.20	.98	3.35	1241	CLL-6006	10.83	3.78	CAT-600
25.39	37.20	16.93	12.99	Tr 330 x 6	3.35	7.64	.20	.98	3.35	1625	CLL-60012	10.83	3.78	CAT-600
17.91	19.88	19.88	15.24	Tr 387 x 6	3.94	8.82	.20	.98	3.94	1565	CLL-8002	12.60	4.84	CAT-800
21.85	27.76	19.88	15.24	Tr 387 x 6	3.94	8.82	.20	.98	3.94	1918	CLL-8006	12.60	4.84	CAT-800
27.76	39.57	19.88	15.24	Tr 387 x 6	3.94	8.82	.20	.98	3.94	2446	CLL-80012	12.60	4.84	CAT-800
19.49	21.46	22.05	17.01	Tr 432 x 6	4.33	9.80	.20	.98	4.33	2094	CLL-10002	14.17	5.35	CAT-1000
23.43	29.33	22.05	17.01	Tr 432 x 6	4.33	9.80	.20	.98	4.33	2517	CLL-10006	14.17	5.35	CAT-1000
29.33	41.14	22.05	17.01	Tr 432 x 6	4.33	9.80	.20	.98	4.33	3151	CLL-100012	14.17	5.35	CAT-1000

▼ Shown from left to right: JHA-356, JHA-156



- All-directional operation on 7, 15 and 35 ton models (JHA- Series)
- Internal relief valve to prevent overloading
- Machined flat front and bottom surfaces permit flush alignment in tight corners
- All models include pumping handle
- Chrome plated plungers
- Automatic by-pass port to prevent over-extension (JH-Series)

JH, JHA Series

Capacity:
7-150 tons

Stroke:
3.00-6.13 inches

Maximum Operating Pressure:
10,000 psi



Lifting Wedge and Machine Lifts

Ideal to lift the load the first few inches. The **LW-16** Lifting Wedge requires a very small access gap of only .39 inch.

Page: 168



Load Skates

For moving heavy loads easily and safely.

Page: 170

Style	Jack Capacity (ton)	Stroke (in)	Model Number	Jack Effective Area (in ²)	Collapsed Height (in)	Extended Height (in)	Bottom Plate Dimensions (W x L) (in)	Plunger Diameter (in)	Pump Speed	Weight (lbs)
Aluminum Jack	7	3.00	JHA-73	1.49	5.25	8.25	2.88 x 6.25	1.19	Single	11
	15	6.06	JHA-156	3.14	9.75	15.81	3.63 x 9.38	1.63	Single	29
	35	6.13	JHA-356	7.07	10.13	16.25	4.63 x 10.00	2.13	Single	40
	75	6.06	JHA-756	15.90	11.25	17.31	6.88 x 12.81	4.50	Single	94
	150	6.13	JHA-1506	30.68	12.88	19.00	9.50 x 16.06	6.25	2-Speed	210
Steel Jack	30	6.13	JH-306	5.94	10.00	16.13	3.75 x 9.56	2.75	Single	59
	50	6.09	JH-506	9.62	10.25	16.34	5.00 x 10.19	3.50	2-Speed	90
	100	6.06	JH-1006	20.63	11.31	17.37	7.13 x 12.94	5.12	2-Speed	184

Industrial Bottle Jacks

▼ Shown: GBJ-010, GBJ-030, GBJ-003



GBJ Series

Capacity:
2-100 tons

Stroke:
2.44-18.11 inches

- Lower handle effort reduces operator fatigue
- Fully serviceable
- High-strength beam and pump linkage for long life
- Pumping handle included on all models
- Safety relief valve to prevent overload
- Automatic by-pass port to prevent over-extension
- Wiper seal for extended life
- Thick base material with large area for increased strength and stability during lifting



Screw Feature

Heat treated, adjustable extension screw with cleated saddle on selected GBJ models helps adjusting and prevents slipping.

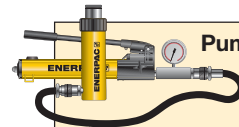

Pump and Cylinder Sets

As an alternative to Industrial Bottle Jacks where the operator is required to stand remote from the jacking point, see the range of pump and cylinder sets.

Page: 54

Jack Capacity (ton)	Stroke (in)	Model Number	Screw Extension (in)	Minimum Height (in)	Maximum Height (in)	Plunger Diameter (in)	Saddle Diameter (in)	Base Dimensions L x W (in)	Weight (lbs)
2	18.11	GBJ002L	-	22.44	40.55	1.14	-	5.00 x 5.00	13.2
2	3.94	GBJ002	1.97	6.30	12.20	0.83	0.83	3.74 x 4.37	7.9
3	4.13	GBJ003	2.56	6.61	13.31	0.94	0.94	3.74 x 4.57	8.6
5	5.91	GBJ005	2.95	8.35	17.20	1.14	1.14	3.74 x 4.84	11.0
8	5.91	GBJ008	2.95	8.62	17.48	1.30	1.46	3.74 x 5.43	13.0
10	5.91	GBJ010	2.95	8.62	17.48	1.46	1.46	3.74 x 5.59	14.3
10	2.44	GBJ010S	1.18	5.16	8.78	1.46	1.46	3.74 x 5.59	12.1
15	5.91	GBJ015	2.95	8.98	17.83	1.75	1.73	4.41 x 6.42	19.8
20	5.91	GBJ020	2.95	9.21	18.07	2.01	2.28	5.00 x 6.73	26.7
20	4.13	GBJ020S	2.17	7.48	13.78	2.01	2.28	5.00 x 6.73	22.0
30	5.91	GBJ030	2.95	9.53	18.39	2.26	2.56	5.59 x 7.72	34.2
50	5.91	GBJ050	-	9.92	15.83	3.15	3.15	7.09 x 9.06	62.8
100	5.91	GBJ100	-	11.81	17.72	4.33	3.70	11.65 x 13.11	191.8

All GBJ Jacks meet or exceed: ANSI, PALD, CE

▼ Shown: PRASA10027L



Safe, Efficient, Mobile Load Lifting

- 60, 100, 150 and 200-ton capacities with pneumatic or electric pumps for the toughest jobs
- 4" ground clearance for transport over rail and rough terrain
- Three position handle provides easy tilt back and transport
- Complies with ASME/ANSI B30.1:2015 & CE specifications
- Easy to change external filter minimizes down time
- Rugged, fully enclosed 24" wide frame with no exposed fittings or hoses
- SUP-R-STACK™ Extension System allows lifting at all heights without blocking.



Pendant Cord

Standard 12' pendant cord for air driven units with pneumatic valves and 20' pendant cord for electric driven units keeps operator away from the load.

▼ Versatility for rail maintenance. One jack for all cars from Intermodal to High Hopper with 28 heights in between.



Capacity	Stroke	Electric Pump Model Number	Weight
(ton)	(in)	(115 VAC)	(lbs)
60	14	PREMB06014L	390
	27	PREMB06027L	600
100	16	PREMB10016L	510
	27	PREMB10027L	600
	16	-	-
150	27	-	-
	15.5	-	-
	26.5	-	-
	15.5	PREMB15016L	570
200	26.5	PREMB15027L	708
	15.5	-	-
	26.5	-	-

(PR-Series not available in Canada. Contact Enerpac.)

POW'R-RISER® Lifting Jack

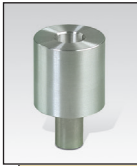

SUP-R-STACK™ Extensions

Increase useful height from 5" to 18".

Model No.	Size (in)	Model No.	Size (in)
PRE5	5	PRE11	11
PRE7	7	PRE14	14
PRE9	9	PRE18	18
PRES6024	Extension set includes PRE5, PRE7, PRE11, PRE18		

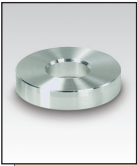

Spacers

Fine tune your Extension stack height.

Model No.	Size (in)	Model No.	Size (in)
PRS1	1	PRS3	3
PRS2	2	-	-
PRS4	Set includes (2) PRS1, (1) PRS2 and (1) PRS3		

PR Series



Rated Lifting Capacity:

60-200 tons

Stroke:

14-27 inches

Maximum Operating Pressure:

10,000 psi



WARNING!

Extensions: Any two Extensions may be stacked for loads up to 60 tons. For loads over 60 tons or strokes over 14" only one Extension and one Spacer can be used.

Spacers: Never exceed 3" in total Spacer height.

Cap. (ton)	Swivel Load Cap	Locking U-Rings					Set Model Number	Locking U-Ring Sets Include			
		1 in.	3 in.	4 1/4 in.	5 1/2 in.	10 in.		(quantity and model numbers)			
								2X	1X	2X	1X
60	PRTS60	PRU11	PRU13	PRU14	-	PRU110	1) PRUS126	PRU11	PRU13	PRU14	-
							2) PRUS137	PRU11	PRU13	PRU14	PRU10
100	PRTS60	PRU11	PRU13	PRU14	-	PRU110	1) PRUS126	PRU11	PRU13	PRU14	-
							2) PRUS137	PRU11	PRU13	PRU14	PRU110
150	PRTS150	PRU151	PRU153	-	PRU155	PRU1510	3) PRUS1526	PRU151	PRU153	PRU155	-
							2) PRUS1537	PRU151	PRU1510	PRU155	-
200	PRTS200	PRU201	PRU203	-	PRU205	PRU2010	3) PRUS2026	PRU201	PRU203	PRU205	-
							2) PRUS2037	PRU201	PRU2010	PRU205	-

1) For 14 and 16" stroke models

2) For 27" stroke models

3) For 15.5" stroke models

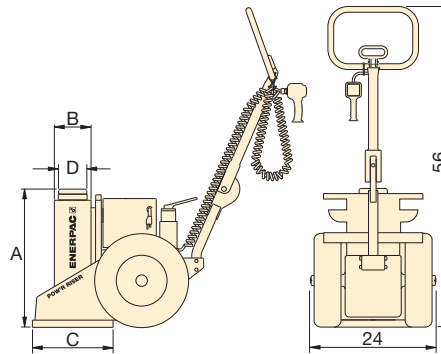

Air Pump	Weight (lbs)	A (in)	B (in)	C (in)	D (in)	Max. Additional Stack Height Using Optional Ext. System (in)	Valve Type
PRAMA06014L	390	24	6.4	14	4	32*	Manual
PRAMA06027L	600	37	6.4	14	4	11	
PRAMA10016L	510	26	7.0	18	4	21**	Pneumatic
PRAMA10027L	600	37	7.0	18	4	11	
PRASA10016L	510	26	7.0	18	4	21**	
PRASA10027L	600	37	7.0	18	4	11	
PRASA15016L	570	26	8.0	18	5	21**	Pneumatic
PRASA15027L	708	37	8.0	18	5	11	
-	-	26	8.0	18	5	21**	Manual
-	-	37	8.0	18	5	11	
PRASA20016L	640	26	9.5	20	6	21**	Pneumatic
PRASA20027L	825	37	9.5	20	6	11	

For power source, the following characters should be inserted in the 5th space of the model number.

Ordering Example:

Model No. PREMI06014L is a 14" stroke, 60 ton model, with a manual valve and a 208-240 VAC, 1-ph electric motor.

- A Air Pump, 50 scfm, 80 psi
- B 115 VAC, 1-ph., 50-60 Hz, 20 A
- E 208-240 VAC, 1-ph., 50-60 Hz, Euro Plug, 10 A
- I 208-240 VAC, 1-ph., 50-60 Hz, USA Plug, 10 A
- G 1)208-240 VAC, 3-ph., 50-60 Hz
- W 1)380-415 VAC, 3-ph., 50-60 Hz
- J 1)440-480 VAC, 3-ph., 50-60 Hz
- R 1)575 VAC, 3-ph., 50-60 Hz

1) Not available for 60-ton capacity

* Based on one 18" and one 11" Extension and one 3" Spacer.

** Based on one 18" Extension and one 3" Spacer.

▼ Shown from left to right: P-142ALSS, P-392ALSS, V-152NV, V-66NV, RC256NV, RC-106NV, RC-53NV



Maximum Corrosion Resistance



Applications

Use Enerpac **Extreme Environment Products** in wet environments such as food processing, pulp and paper, mining, construction and applications in high temperature or in welding areas.

- Corrosion resistant, nickel-plated valves and cylinders
- Stainless steel pump inserts will not corrode
- Viton® Seals provide heat and chemical resistance
- Anodized aluminum pump reservoirs and plastic encapsulated pump bodies resist wet environments
- Two-speed operation reduces pump handle strokes 78% compared to single-speed pumps
- Pump handles lock for easy carrying



700, 900 Series Hoses

Enerpac offers a complete line of high-quality hydraulic hoses. To ensure the integrity of your system, specify only genuine Enerpac hydraulic hoses.

Page: **114**

▼ CYLINDER CHART



Cylinder Capacity	Stroke	Model Number	Oil Capacity	Pressure Rating	Port Dimension	Collapsed Height	Extended Height	Outside Diameter
						A (in)	B (in)	D (in)
5 (ton)	3.0 (in)	RC-53NV	2.98 (in ³)	10,000 (psi)	3/8"-18 NPTF (in)	6.50	9.50	1.50
10	2.0	RC-102NV	4.75	10,000	3/8"-18 NPTF	4.78	6.91	2.25
10	6.0	RC-106NV	13.70	10,000	3/8"-18 NPTF	9.75	15.88	2.25
25	6.0	RC-256NV	32.23	10,000	3/8"-18 NPTF	10.75	17.00	3.38

▼ HAND PUMP CHART



Pump Type	Oil Capacity	Model Number	Pressure Rating	Oil Displacement per Stroke	Port Dimension	Piston Stroke
	(in ³)		(psi)	(in ³)	(in)	(in)
Two Speed	20	P-142ALSS	200/10,000	0.221/0.055	1/4"-18 NPTF	.50
	55	P-392ALSS	200/10,000	0.687/0.151	3/8"-18 NPTF	1.00

▼ VALVE CHART*



Valve Type	Model Number	Pressure Function	Pressure Rating (psi)
Manual Check Valve	V-66NV	Check	10,000
Pressure Relief Valve	V-152NV	+ 3% Repeatability	800-10,000

* See page 128 for valve function information of standard model products.

P-392ALSS

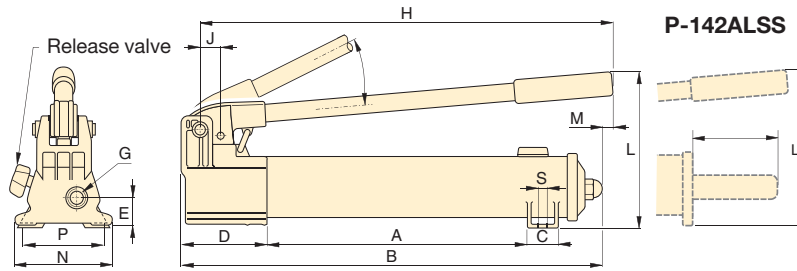

P-142ALSS

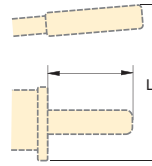

RC P V Series



Cylinder Capacity:
5-25 tons

Stroke:
2-6 inches

Maximum Operating Pressure:
10,000 psi

RC-102NV, RC-106NV, RC-256NV

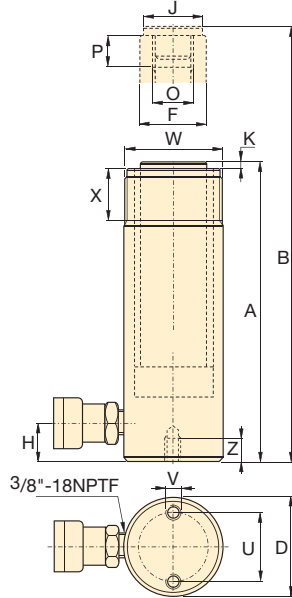

V-66NV

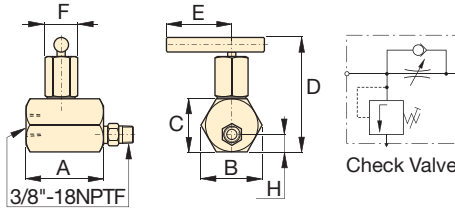

V-152NV

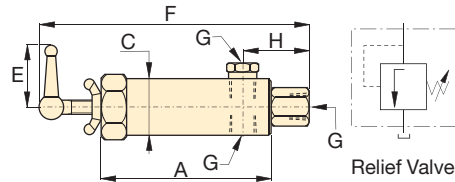

Multifluid Hand Pumps

MP-Series corrosion resistant hand pumps for low pressure filling and high pressure testing applications, suitable for a wide range of fluids.

Page: **65**

Plunger Diam.	Base to Adv. Port	Saddle Diam.	Saddle Protrusion from Plng.	Plunger Internal Thread	Plunger Thread Length	Base Mounting Holes			Collar Thread	Collar Thread Length	Weight (lbs)	Model Number
						Bolt Circle U (in)	Thread V (in)	Thrd. Depth Z (in)				
1.00	.75	1.00	.25	3/4"-16	.56	1.00	1/4"-20UN	.56	1 1/2"-16	1.13	3.3	RC-53NV
1.50	.75	1.38	.25	1"-8	.75	1.56	5/16"-18UN	.50	2 1/4"-14	1.13	5.1	RC-102NV
1.50	.75	1.38	.25	1"-8	.75	1.56	5/16"-18UN	.50	2 1/4"-14	1.13	9.8	RC-106NV
2.25	1.00	2.00	.41	1 1/2"-16	1.00	2.31	1/2"-13UN	.75	3 5/16"-12	1.94	22.0	RC-256NV

Pump Dimensions (in)													Weight (lbs)	Model Number
A	B	C	D	E	G	H	J	L	M	N	P	S		
7.31	13.25	1.13	3.37	1.13	1/4"-18 NPTF	12.56	.75	5.63	-	3.75	3.18	.28	4.5	P-142ALSS
13.56	21.00	1.44	3.93	1.31	3/8"-18 NPTF	20.56	1.19	7.00	.63	4.75	-	-	9.0	P-392ALSS

Valve Dimensions (in)									Weight (lbs)	Model Number
A	B	C	D	E	F	G	H			
3.50	2.25	2.00	4.00	2.00	0.87	3/8"-18 NPTF	1.00	3.9	V-66NV	
4.53	-	1.50	-	3.12	7.62	3/8"-18 NPTF	1.53	3.5	V-152NV	

▼ Shown cylinder-pump set: **SCR-1010H**



The Quickest and Easiest Way to Start Working Right Away





- Optimum match of individual components
- Sets include 6 foot safety hose, calibrated gauge with gauge adaptor
- All hand pumps are two-speed



Speed Chart

See the Enerpac Cylinder Speed Chart in our “Yellow Pages” section.

Page: 251

 Cylinder Selection (See Cylinder Section of this catalog for full product descriptions)		Nominal Set Capacity (ton)	Cylinder Model No.	Stroke (in)	Collapsed Height (in)
 <p>Single-acting, General Purpose Cylinders: For maximum versatility. RC-Series DUO</p>	5	RC-55	5.00	8.50	
		10	RC-102	2.13	4.78
	RC-106		6.13	9.75	
	RC-1010		10.13	13.75	
	15	RC-154	4.00	7.88	
		RC-156	6.00	10.69	
	25	RC-252	2.00	6.50	
		RC-254	4.00	8.50	
RC-256		6.25	10.75		
50	RC-2514	14.25	18.75		
	RC-506	6.25	11.13		
 <p>Single-acting, Low Height Cylinders: Ideal where space is restricted. RCS-Series</p>	10	RCS-101	1.50	3.47	
	20	RCS-201	1.75	3.88	
	30	RCS-302	2.44	4.63	
	50	RCS-502	2.38	4.81	
	100	RCS-1002	2.25	5.56	
 <p>Single-acting, Hollow Cylinders: For pushing and pulling applications. RCH-Series</p>	12	RCH-121	1.63	4.75	
	20	RCH-202	2.00	6.31	
	30	RCH-302	2.50	7.03	
	60	RCH-603	3.00	9.75	
 <p>Pull Cylinders: The ultimate in pulling power. BRP-Series</p>	10	BRP-106C	5.95	23.11	
		BRP-106L	5.95	21.33	
	30	BRP-306	6.10	42.72	
	60	BRP-606	5.98	28.34	
	–	–	–	–	

Single-Acting, Cylinder Pump Sets

SELECTION EXAMPLE

Selected cylinder:

- RC-106, Single-acting cylinder with 6.13" stroke

Selected pump:

- P-392, Lightweight hand pump

Set model number:

- SCR-106H

Included:

- HC-7206 hose
- GF-10P gauge
- GA-2 adaptor

SET SELECTION:

- 1 Select the cylinder
- 2 Select the pump
- 3 Find the set model number in the blue field of the matrix

SC Series



Capacity:

5-100 tons

Stroke:

1.50-14.25 inches

Maximum Operating Pressure:

10,000 psi

2

Pump selection (See Pump Section of this catalog for full product descriptions)

Accessories Included

Hand Pump P-142	Hand Pump P-392	Hand Pump P-80	Foot Pump P-392FP	XA-Series Air Pump XA-11	Hose Model No.	Gauge Model No.	Gauge Adaptor Model No.
SCR-55H	-	-	-	-	HC-7206	GP-10S	GA-4
-	SCR-102H	-	SCR-102FP	SCR-102XA	HC-7206	GF-10P	GA-2
-	SCR-106H	-	SCR-106FP	SCR-106XA	HC-7206	GF-10P	GA-2
-	SCR-1010H	-	SCR-1010FP	SCR-1010XA	HC-7206	GF-10P	GA-2
-	SCR-154H	-	SCR-154FP	SCR-154XA	HC-7206	GP-10S	GA-2
-	SCR-156H	-	SCR-156FP	SCR-156XA	HC-7206	GP-10S	GA-2
-	SCR-252H	-	SCR-252FP	SCR-252XA	HC-7206	GF-20P	GA-2
-	SCR-254H	-	SCR-254FP	SCR-254XA	HC-7206	GF-20P	GA-2
-	SCR-256H	-	-	SCR-256XA	HC-7206	GF-20P	GA-2
-	-	SCR-2514H	-	SCR-2514XA ¹⁾	HC-7206	GF-20P	GA-2
-	-	SCR-506H	-	SCR-506XA ¹⁾	HC-7206	GF-50P	GA-2
-	SCL-101H	-	SCL-101FP	SCL-101XA	HC-7206	GF-10P	GA-2
-	SCL-201H	-	SCL-201FP	SCL-201XA	HC-7206	GF-230P	GA-2
-	SCL-302H	-	SCL-302FP	SCL-302XA	HC-7206	GF-230P	GA-2
-	SCL-502H	-	SCL-502FP	SCL-502XA	HC-7206	GF-510P	GA-2
-	-	SCL-1002H	-	-	HC-7206	GF-510P	GA-2
SCH-121H	-	-	-	-	HB-7206	GF-120P	GA-4
-	SCH-202H	-	SCH-202FP	SCH-202XA	HC-7206	GF-813P	GA-3
-	SCH-302H	-	SCH-302FP	SCH-302XA	HC-7206	GF-813P	GA-3
-	-	SCH-603H	-	SCH-603XA ¹⁾	HC-7206	GF-813P	GA-3
-	-	SCH-1003H	-	-	HC-7206	GP-10S	GA-2
-	SCP-106CH	-	SCP-106CFP	-	HC-7206	GP-10S	GA-2
-	SCP-106LH	-	SCP-106LFP	-	HC-7206	GP-10S	GA-2
-	-	SCP-306H	-	-	HC-7206	GP-10S	GA-2
-	-	SCP-606H	-	-	HC-7206	GP-10S	GA-2
-	-	-	-	-	-	-	-

¹⁾ XA-12